

| | | | |
|--|--|--|--|
| | | | |
| | | | |
| | | | |

HM%%

J' "\$



L]UaYb Hcd! =ch HMWbc` c[m 7c" ž @hX"

| &\$%! \$! \$& | J% \$ | | |
|---------------|---------|--|--|
| &\$%! \$% &\$ | J% % | | |
| &\$%! \$! \$) | J% & | | |
| &\$&\$" %%" & | J' " \$ | | |

% %

% &

% ' "

& %

& &

& ' " "

.....

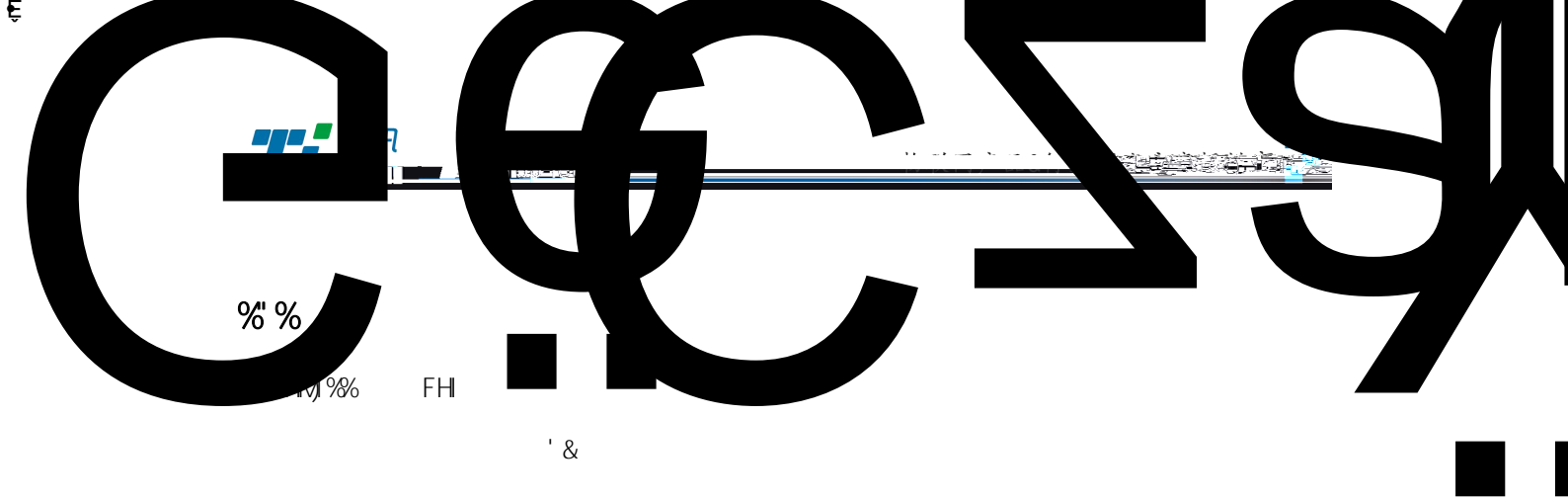

% %

% %

FH

' &

H) % %

FH

& # ; # (;

GNN&\$' ! &\$%&

GNN&\$) ! &\$%&

ž

& # ; # (;

#

&

%

%& & FG&' & & FG(,) , %* 58

(! &\$a5 \$!) J , & ,

H7D# =D (

%* A6

%\$ H fl 匕

#

% &" %

%

&

,

(

)

*

+

,

-

%\$

%%

%&

%*A6

%\$

%

H

%&

N] [6YY

%&

%*

%&

%' '

%' " %



7DI

' &

%' " &

&" %

&" &

&" &" %

- ◇ % fl
- ◇ fIGA5
- ◇ %&J87#%)5 %
- ◇ FG&' & %
- ◇ '\$\$ %
- ◇ %& D=B (%\$ D=B & (D=B %
- ◇
- ◇

&" '



图 2-2 接口编号顺序图

| | | | | |
|------|----------|-----------|-----------|---------|
| | | | | |
| % | | ?\$Z | \$ | |
| & | | ?\$! | \$ | |
| ' | | ?%Z | % | |
| (| | ?%& | % | |
|) | | ?&Z | & | |
| * | | ?&! | & | |
| + | | ?' Z | ' | |
| , | | ?' ! | ' | |
| - | | ?(\$Z | (| |
| /% | | ?(! | (| |
| %% | | ?)\$Z |) | |
| %& | | ?)! |) | |
| %* | | ?*Z | * | |
| %& | | ?*! | * | |
| %) | | ?+Z | + | |
| %& | | ?+! | + | |
| | | | | |
| %+ | | J77SFG& & | FG& & | |
| % | | ; B8 | FG& & | |
| % | FG& & | FL8\$ | \$ FG& & | & FG& & |
| &\$ | | HL8\$ | \$ FG& & | %& &\$ |
| &% | | FL8% | % FG& & | |
| && | | HL8% | % FG& & | |
| | | | | |
| & | | 6\$ | FG(,)! \$ | 6 |
| &(| FG(,)! % | 5\$ | FG(,)! \$ | 5 |
| | | | | |
| &) | | F5=B\$ | \$ | |
| &* | | F5=B% | % | |
| &+ | # | D=\$ | \$ | |
| & | | D=% | % | |
| &- | | ; B8 | | |
| | | | | |
| ' \$ | G8=%& | G8= | G8= | G8= |
| | | | | |
| ' % | | ;\$ | \$ | |
| ' & | | ;% | % | |
| '' | | ;& | & | |



| | | | | |
|-----|----------|----------|----------|------------|
| (| ; | ' | | |
|) | ;(| (| | |
| * |); |) | | |
| + | ;* | * | %& | |
| , | ;+ | + | | |
| - | ;- | - | | |
| (\$ | ;\$ | \$ | | |
| (% | ;%\$ | %\$ | | |
| (& | ;%% | %% | | |
| (' | ;B8 | | | |
| ((| J77S; 5M | | | |
| (| 6% | FG(,)! & | 6 | FG(,) |
| (* | FG(,)! & | 5% | FG(,)! & | 5 |
| | | | | %& \$\$\$ |
| (+ | ; B8 | | | |
| (, | 8=+ | + | | |
| (- | 8=* | * | | |
|)\$ | 8=) |) | | |
|)% | 8=(| (| | |
|)& | 8=' | ' | | |
|)' | 8=& | & | | |
|)(| 8=% | % | | |
|)) | 8=\$ | \$ | | |
|)* | ; B8 | | | |
|)+ | 8\$% | % | | & |
|), | 8\$% | \$ | | |
|)- | 587+ | + | | |
| *\$ | 587* | * | | |
| *% | 587) |) | | |
| *& | 587(| (| | |
| ** | 587' | ' | | (&\$a5 \$ |
| *(| 587& | & | |)J |
| *) | 587% | % | | |
| ** | 587\$ | \$ | | |
| *+ | 587S; B8 | | | |

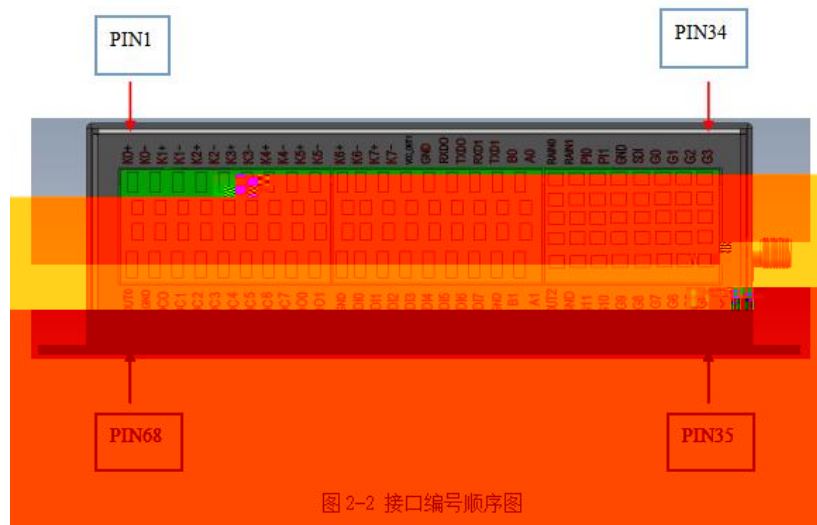
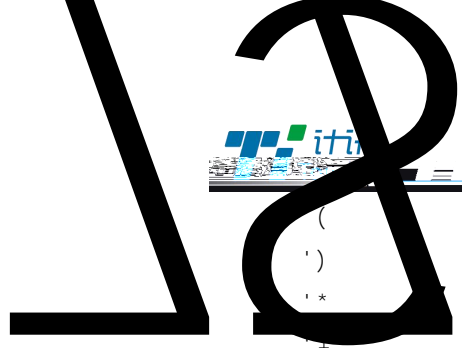
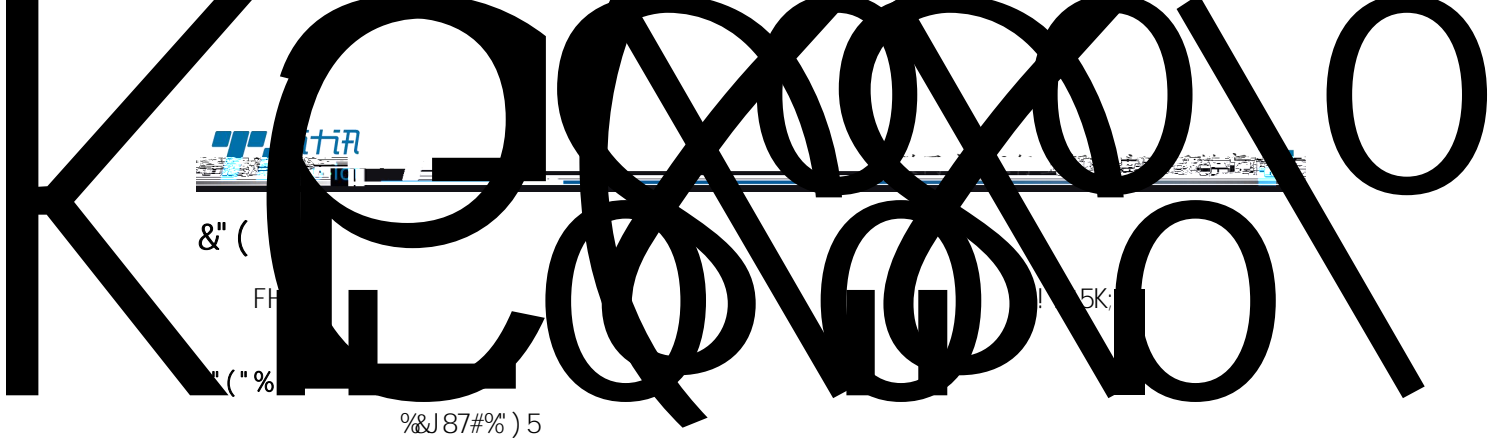

十汛
&" (FH ! 5K:
" (" %
%&J87#%") 5

| | |
|--|--|
| | |
| | |
| | |

FG& & 86-

86-
&

FG(,)

FG(,)

- *\$\$ Vdg

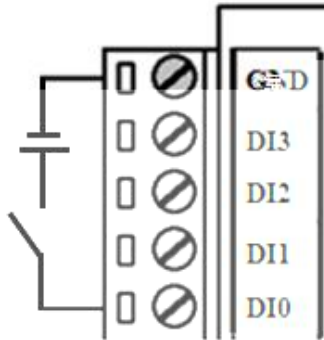
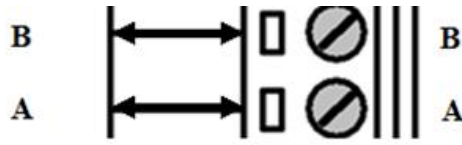

C7

) \$a5

') J87

FZF_cLX_2&\$I

I 01') J87

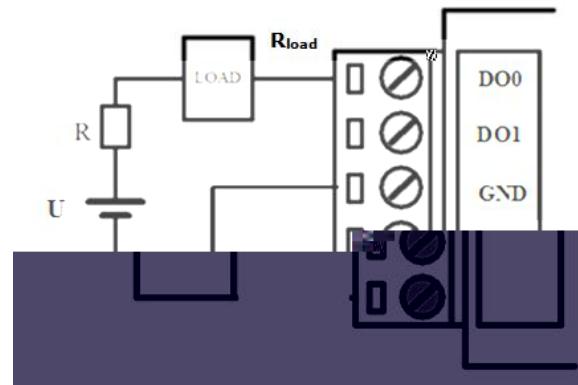

' \$J87

%5

' \$K

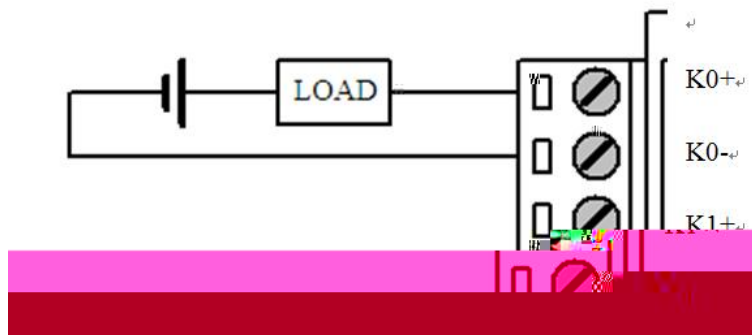

(! &\$a5

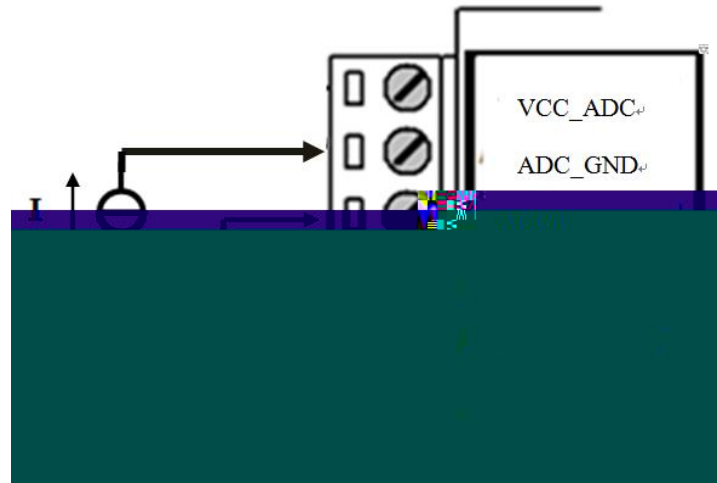

(! &\$a5

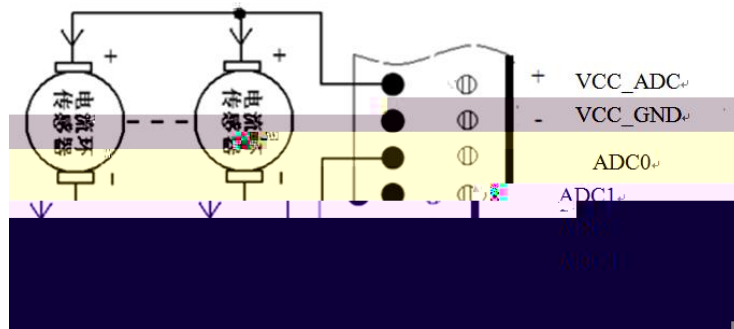

G8=

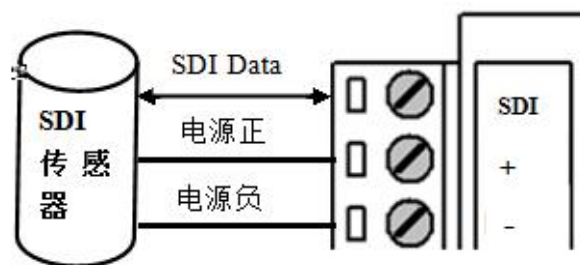

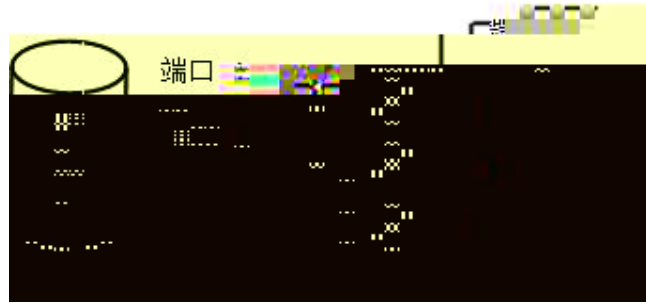

%&

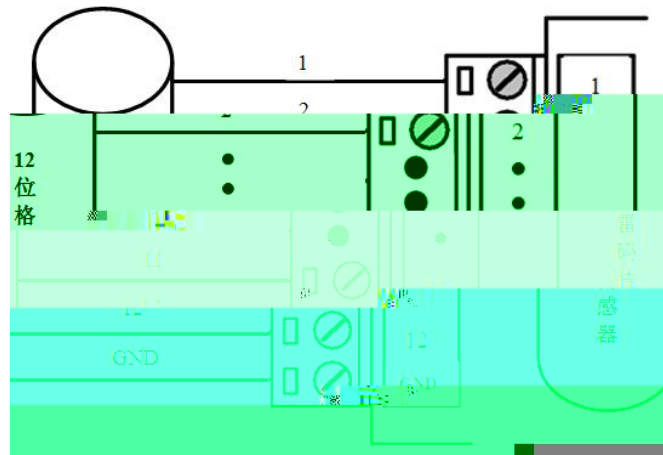

&")

%&87#%) 5

)r' *J

' \$aJ

' *J

(K

%&87#%) 5

&" *

| | | |
|-----|--|--|
| | | |
| DKF | | |

| | | |
|--------|--|--|
| GMG | | |
| Cb`]bY | | |
| 9ffc | | |

&" +



A'

(

&" ,

*

A(

&" -

FH

HM%% FH

FH

FG& & FG(,)

FH



)

FH

' "%

FH

FG(,) FG& &

FH

FH

' "& FH

FH

FH

' ''

FH

FH

GE@ Gyfj Yf &\$\$, f&

' "(

FH

' ")

FH

("%

(

FH

/

("'

FH

FG(,)

%&

(! &\$a5

FH

FG(,)

FH

FG(,)

FH

("(

%

%

(")

FH



(" *

FH

FH

D7

FG&' &

FH

9l W`

D7

(" +

FH

(" ,

FH

; DFG

FH

FH

; DFG

FH

(" -

(" %\$

FH

FH

FH

("%%

FH

; DFG

>D;

("%&

FH ; DFG

; DFG

; DFG

FH

FH

FH

("%

FH

: @5G<

FH

FG' & &

FH

FG& &! % D7

D7

FH

FH

FH

G=A

FH

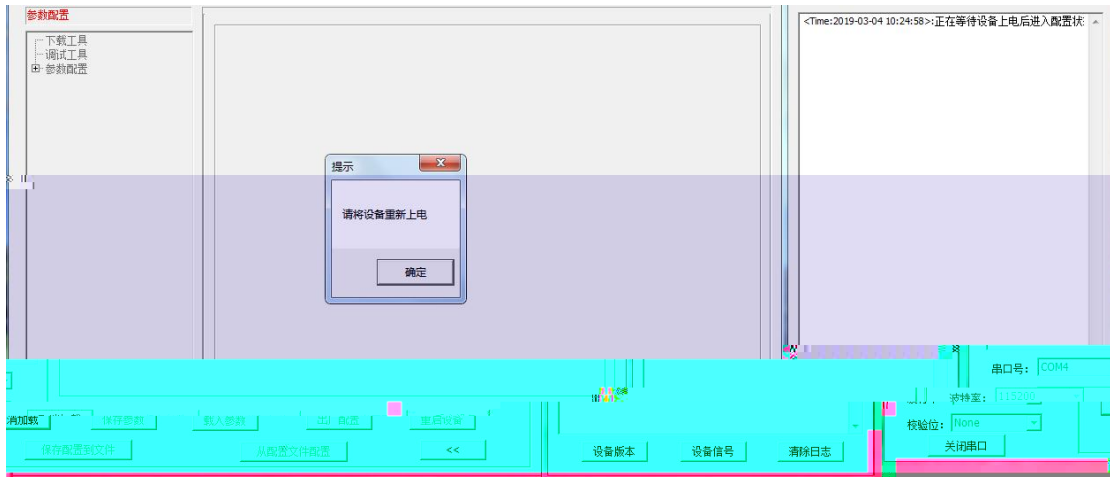

< U i

FH7

HV)%

FH7

)" &" &

HV)%

HV)% '\$

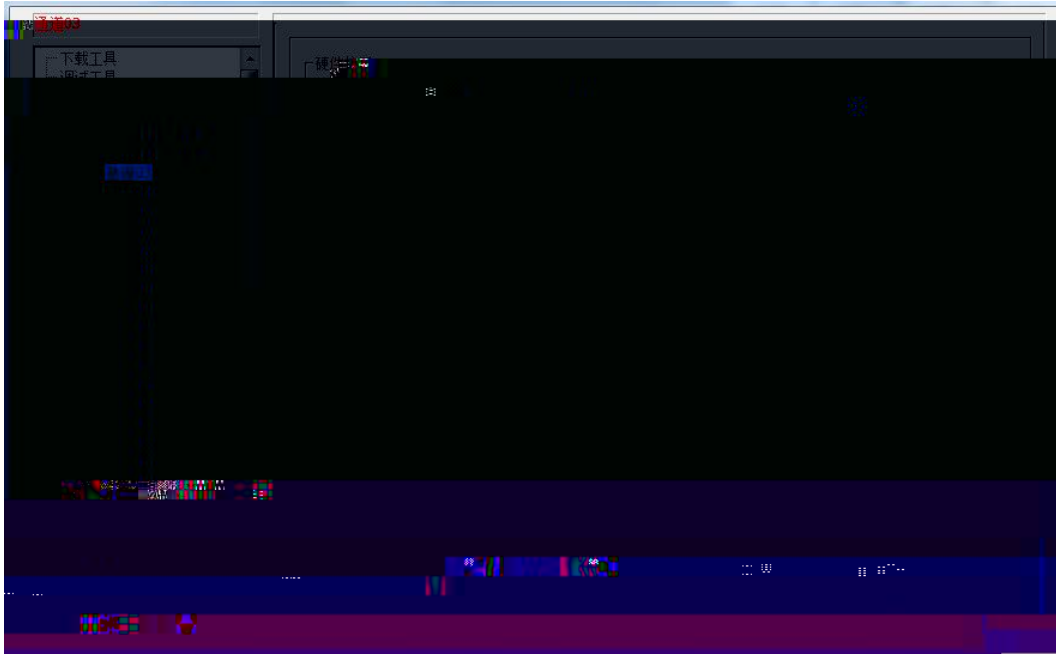



| | |
|--|-----------------|
| | |
| | |
| | HM%% \$!*)')')g |
| | a]b |
| | FH |
| | % \$\$ |
| | |
| | |
| | 5G7== |
| | |
| | |
| | V&PaP a' #g |

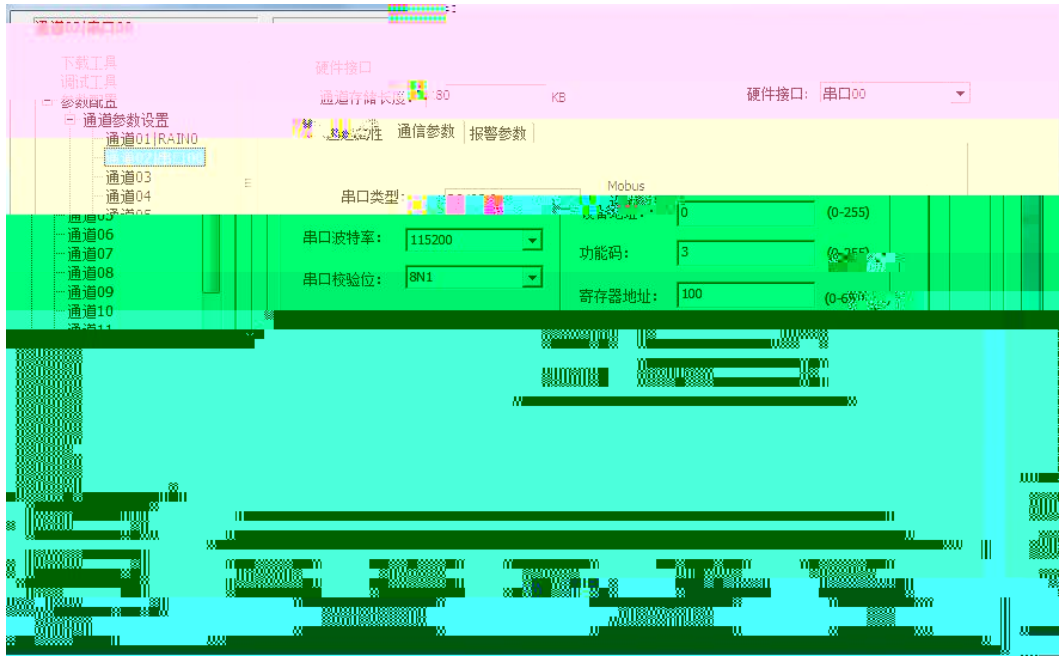

AcXvi g FH

| | |
|--|------------|
| | |
| | |
| | |
| | AC86I G FH |
| | AC86I G FH |
| | |
| | |
| | |

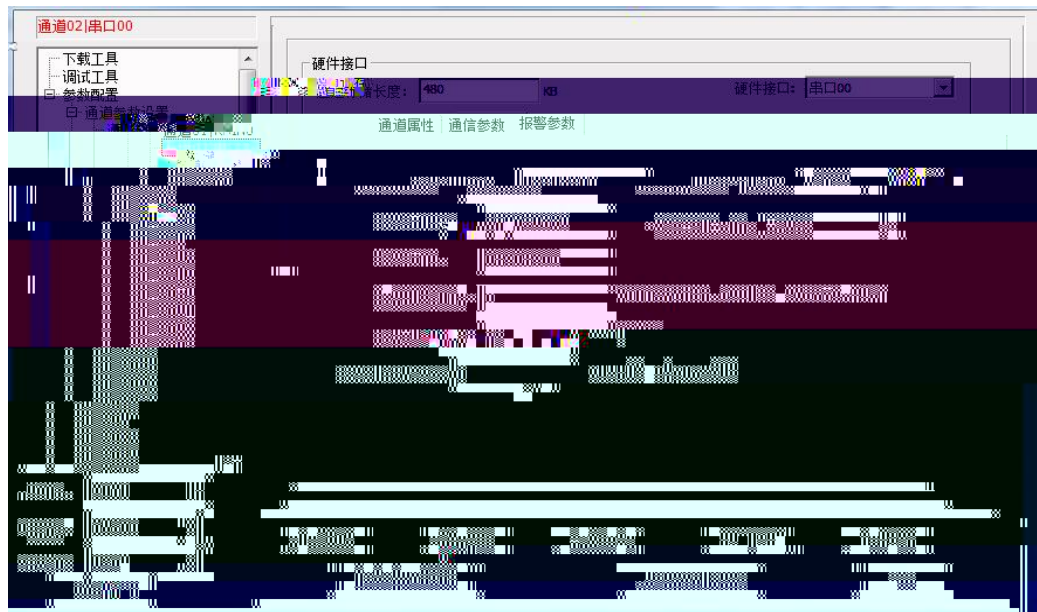

| | |
|----|------------|
| | |
| | |
| | \$ *))') |
| =8 | =8 \$! &)) |
| | \$! &)) \$ |
| | 8C ?\$ |
| | |

)" &" (587

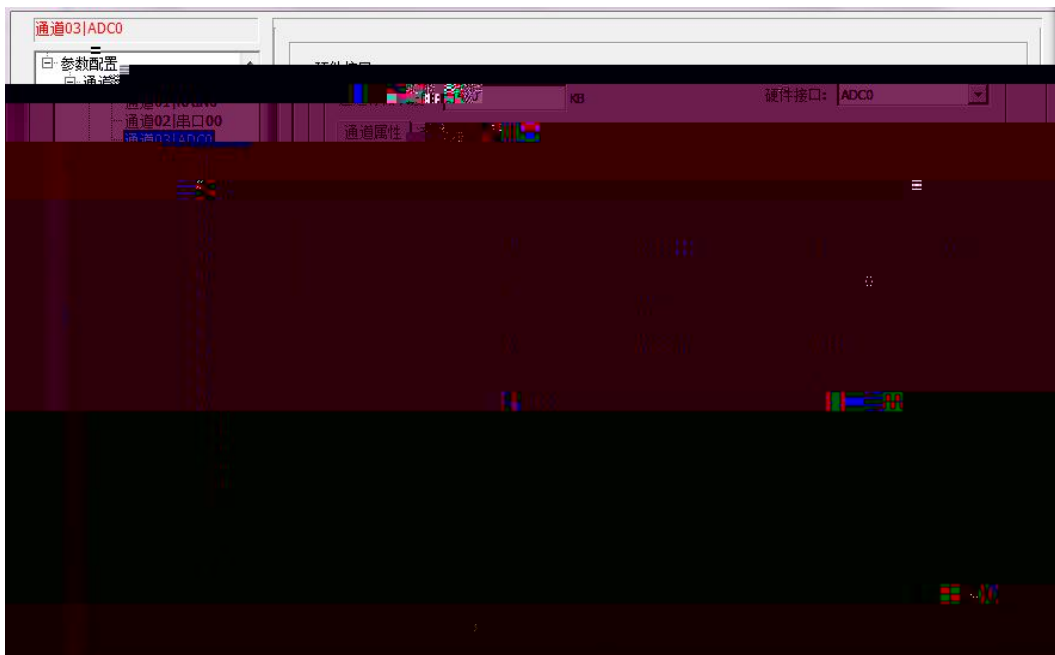

| | |
|--|-------------------|
| | |
| | HV)% \$! *)')')g |
| | a]b |
| | FH |
| | % \$\$\$ |
| | |
| | 5G7== |
| | |
| | VaPaP a' #g |

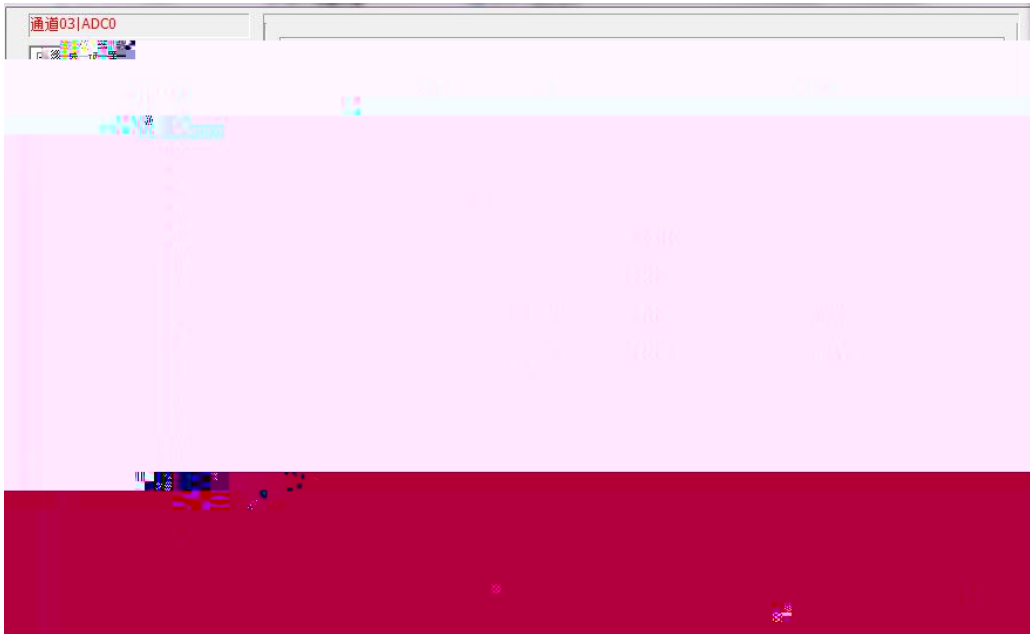

| | |
|-----|---|
| 587 | # |
| | |
| | |
| | |

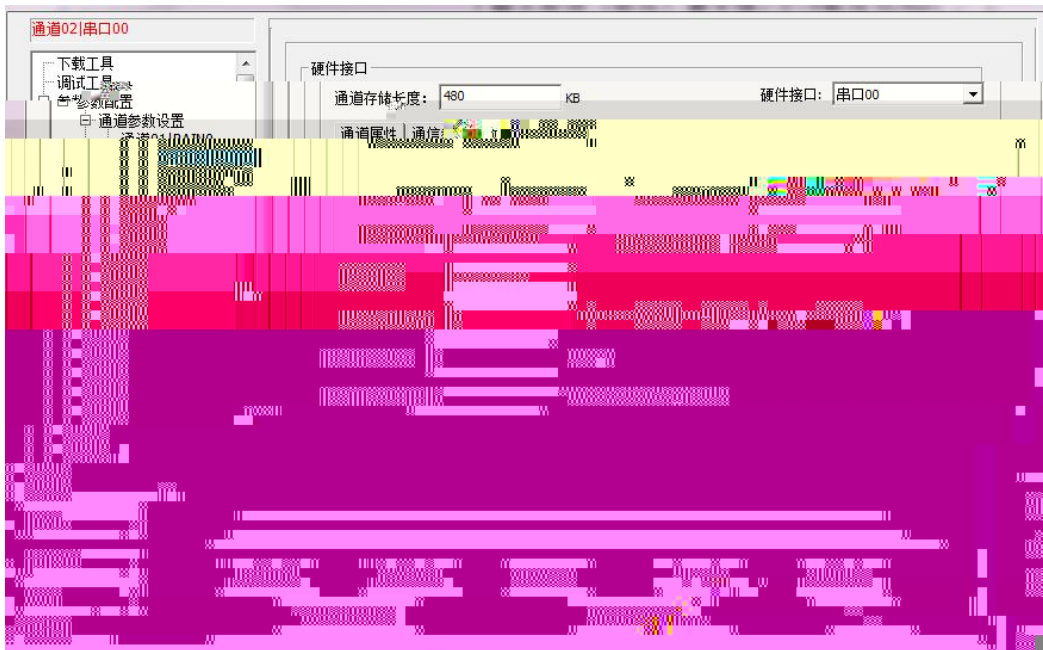

| | |
|----|------------|
| | |
| | |
| | \$ *)))' |
| =8 | =8 \$! &)) |
| | \$! &)) \$ |
| | 8C ?\$ |
| | |

)"&") 8=



| | |
|----|------------|
| | |
| | 8C ?\$ |
| | \$ *)))' |
| =8 | =8 \$! &)) |
| | \$! &)) \$ |

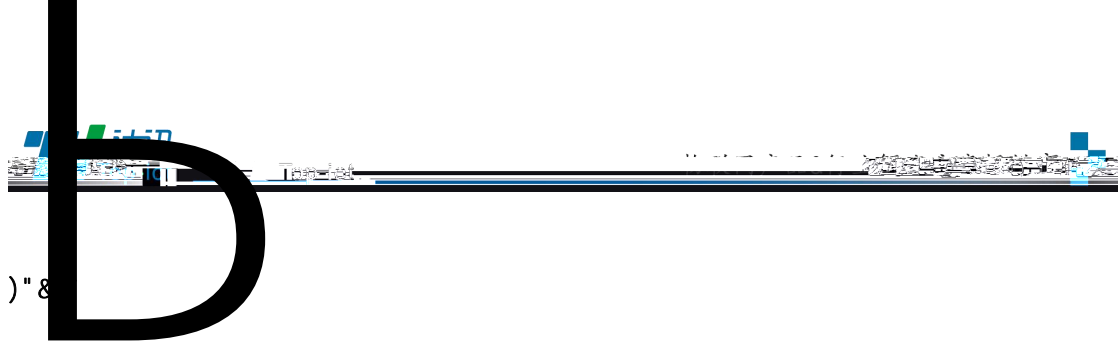

)" &

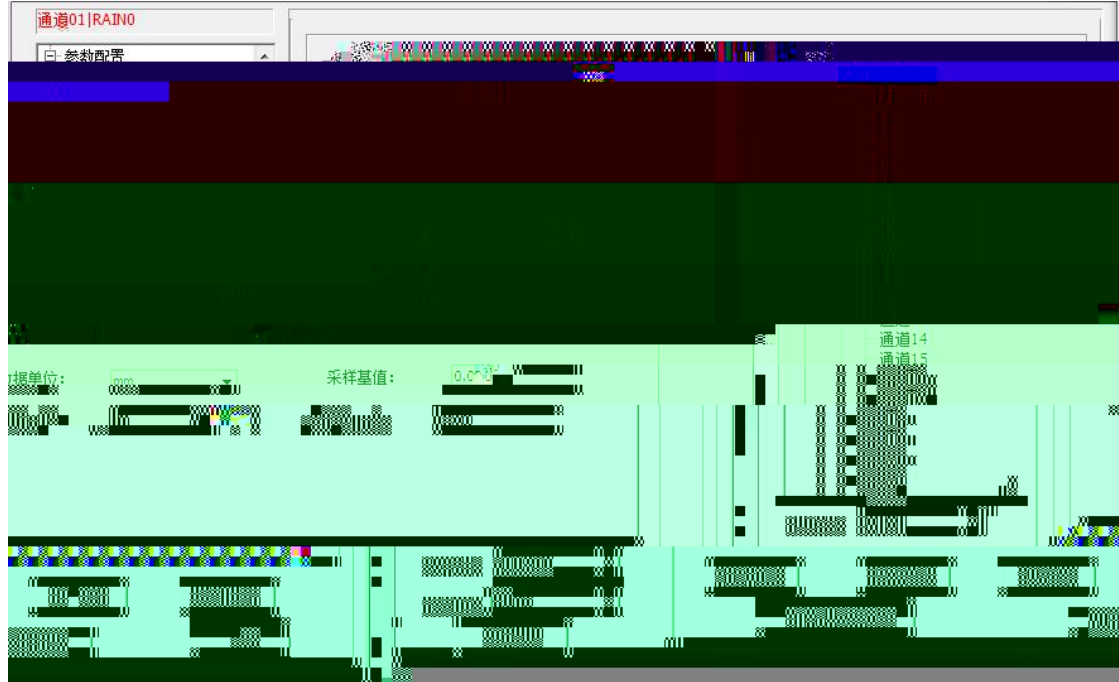

#

a]b

FH

V0PaP a'

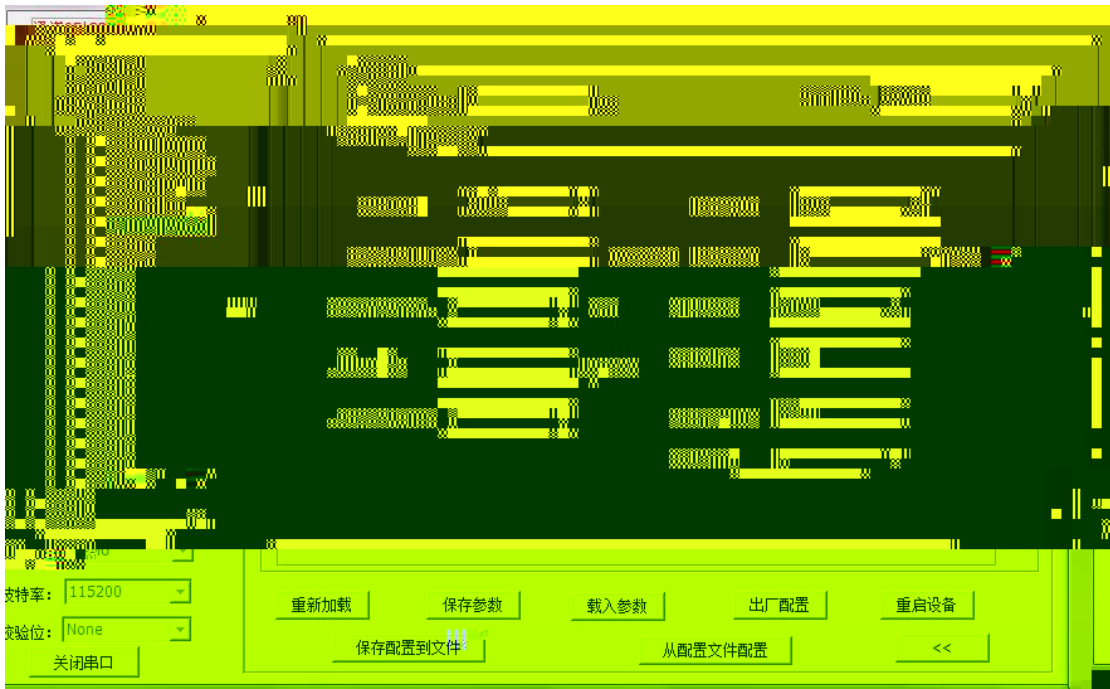

| | |
|--|-------------------|
| | |
| | |
| | H\)% \$! *)')')g |
| | a] b |
| | FH |
| | % \$\$ |
| | |
| | |
| | 5G7== |
| | |
| | V\PaP a' #g |

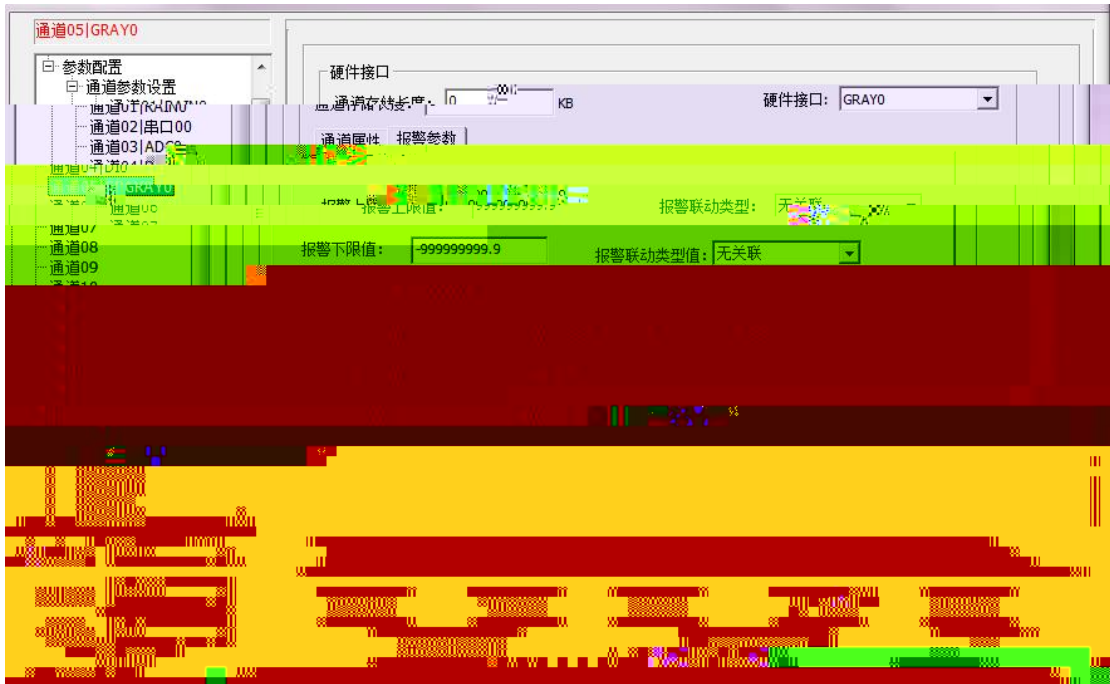

=8 =8 \$! &)) \$ *)')
8C ?\$ \$! &)) \$

)" &',

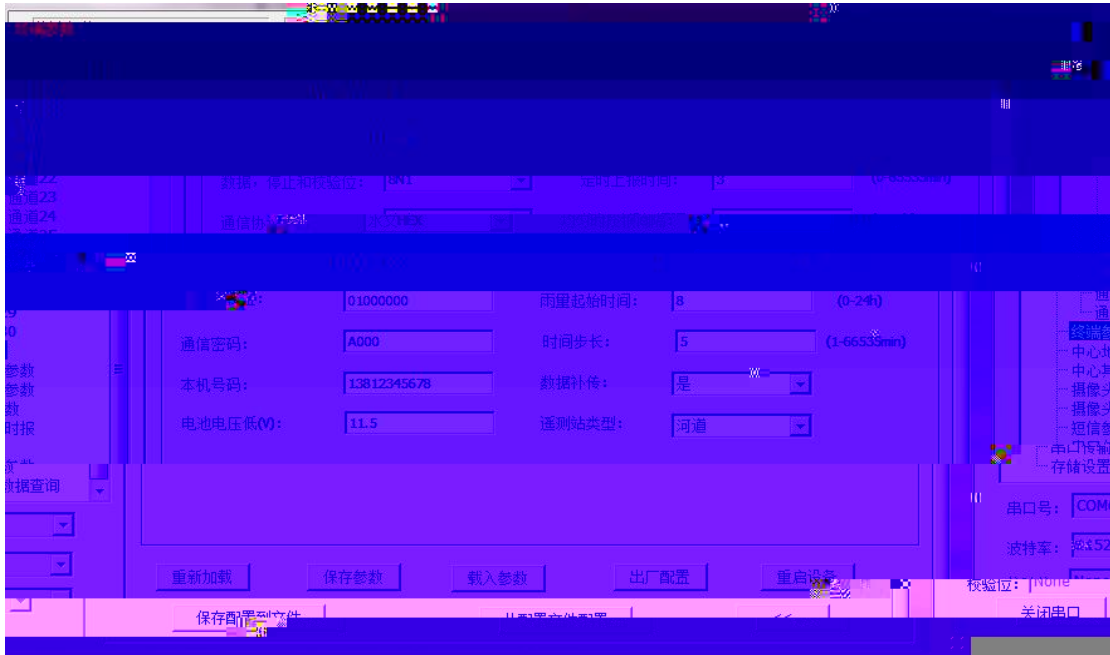

| | |
|--|-----------------------------------|
| | |
| | \$ |
| | % FG&' & \$ |
| | & FG&' & \$ |
| | ' \$\$Vdgr %\$& \$\$Vdg FG&' & \$ |
| | , B% , C% , 9% FG&' & \$ |
| | <9L 5G7== |
| | ;% |
| | & |
| | (|
| | % |
| | J |
| | ' "% |
| | *\$ \$! *)') a] b |
| | % \$! & \ |
| |) \$!) - a] b |
| | , \$! & \ |
| |) % **') a] b |
| |) |
| | |
| | |

)" &" -



| | |
|--|---|
| | |
| | (|
| | GAG#H7D# # # DGHB# # # I 8D ("% - _____ |
| | H7D#I 8D =D GAG |
| | H7D#I 8D |
| | H7D#I 8D 8BG =D |

)" &' %\$

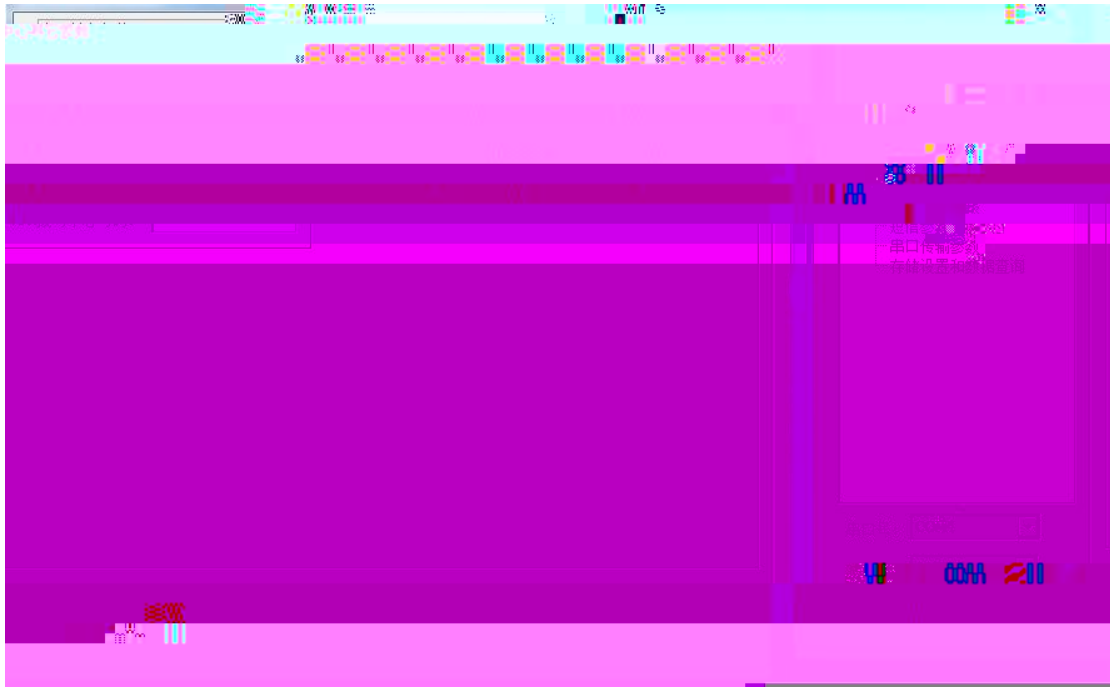

| | |
|-----|------------------|
| | |
| 5DB | |
| 5DB | |
| 5DB | |
| 5DB | |
| | H7D *\$ I 8D ' % |
| | |
| @7D | |

)" & "%%

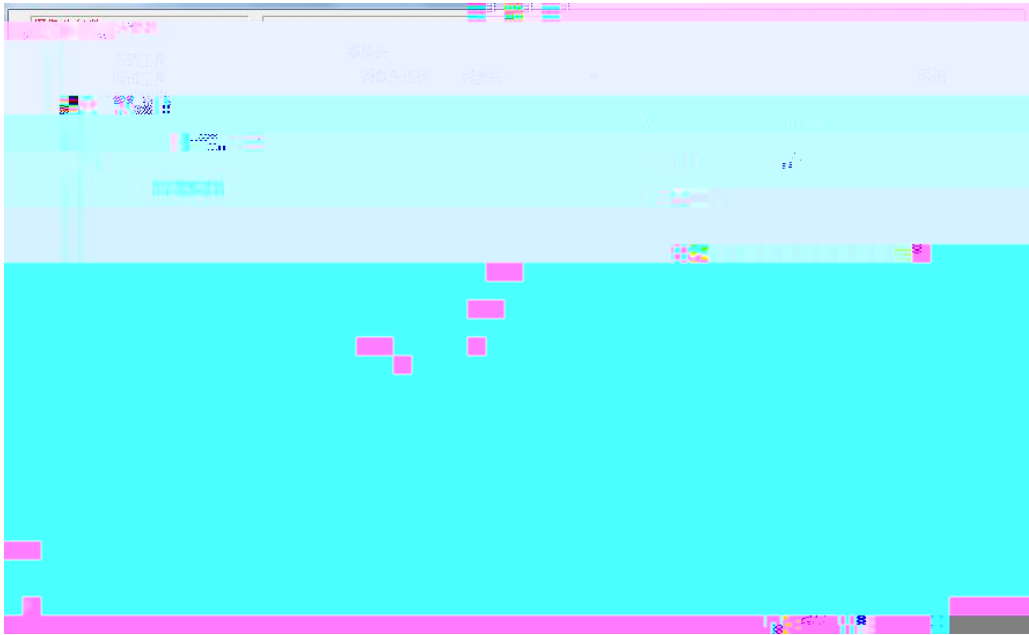

| | |
|----|---|
| =8 | \$! &) |
| | GL<! @/#GL<! @/BI C@8#GL<! @/BI B9K |
| | *(\$! (, \$, \$\$! *\$\$! %\$\$(L+*, %& \$L, \$\$ %& \$L-*\$ |
| | & & ' & (,) |
| | ' \$\$Vdgr %%% &\$\$Vdg |
| | , B% , C% , 9% |
| | |

)" &" %\



| | |
|--|-------------------------|
| | & & & & (,) |
| | ' \$\$Vdgr %%% &\$\$Vdg |
| | , B% , C% , 9% |

)" &" %\



| | |
|--|--|
| | |
| | |
| | |

)''

FH

FH

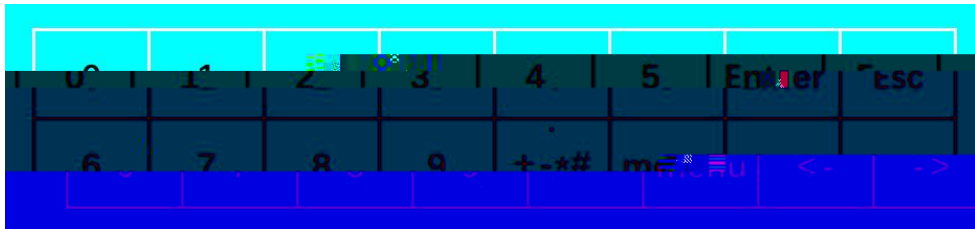

FH



\$ r%

&r-

"

\$

"

Ž

& -

!

†

AYbi

9bhYf

9G7

)""%

@78

l =

(! % FH

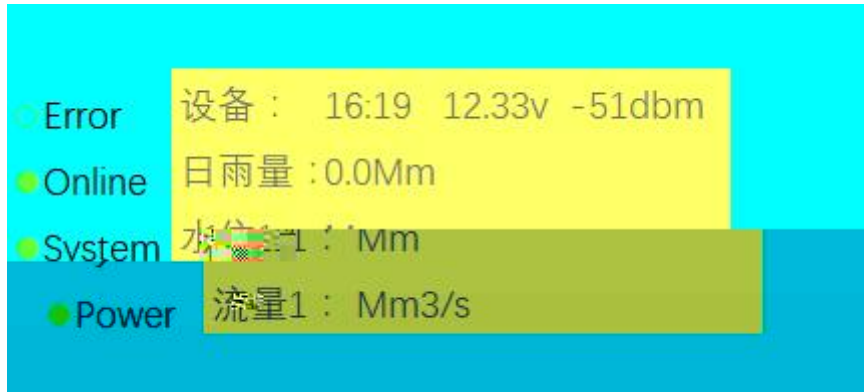

% %

&%) fIAAL

% %

\$" \$fIAAL

FH

H

)""&

AYbi

9bhYf

(! &

(! & FH



@78

FH

FH

FH

)''''

#



&\$% + &&

%& &\$ %&

. &\$% ! \$+! && %% &\$

. %&\$

fl \$" %aak

&\$% (%\$

&\$ ' \$ %*'')

. &\$% ! \$(! %\$ &\$ ' \$

. \$\$%*')

fl aak

&\$% % &

& ' \$ &\$

. &\$% ! \$% & & ' \$

. \$\$\$&\$

fl a' #gk

)'''(

#

9bhYf



FHl

)'''")

#

9bhYf



9bhYf

: @5G<

9gW

)""*

#

9bhYf



FH

HM)%% 7<G\$\$\$! %&" (

H| aY. 5df %* &\$% \$,.)&' +

)""+

#

9bhYf



FH

)" (

%)\$

5H

/

)" (" %

0 / % &2

5H

5HŽ

0%&' () */ AI @H=G9F\$%1%&\$" (&" (*" -, / AI @H=DCFH\$%1) \$\$+2

%&' () *ž

%&\$" (&" (*" -,

) \$\$+

5H

5H

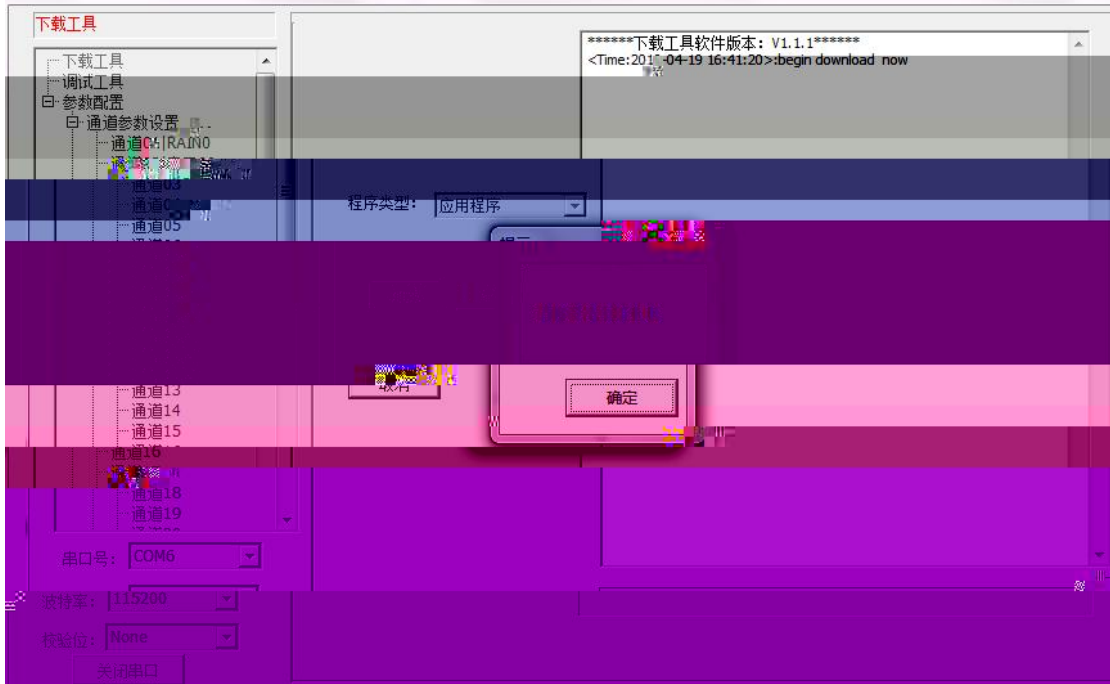

' " FH

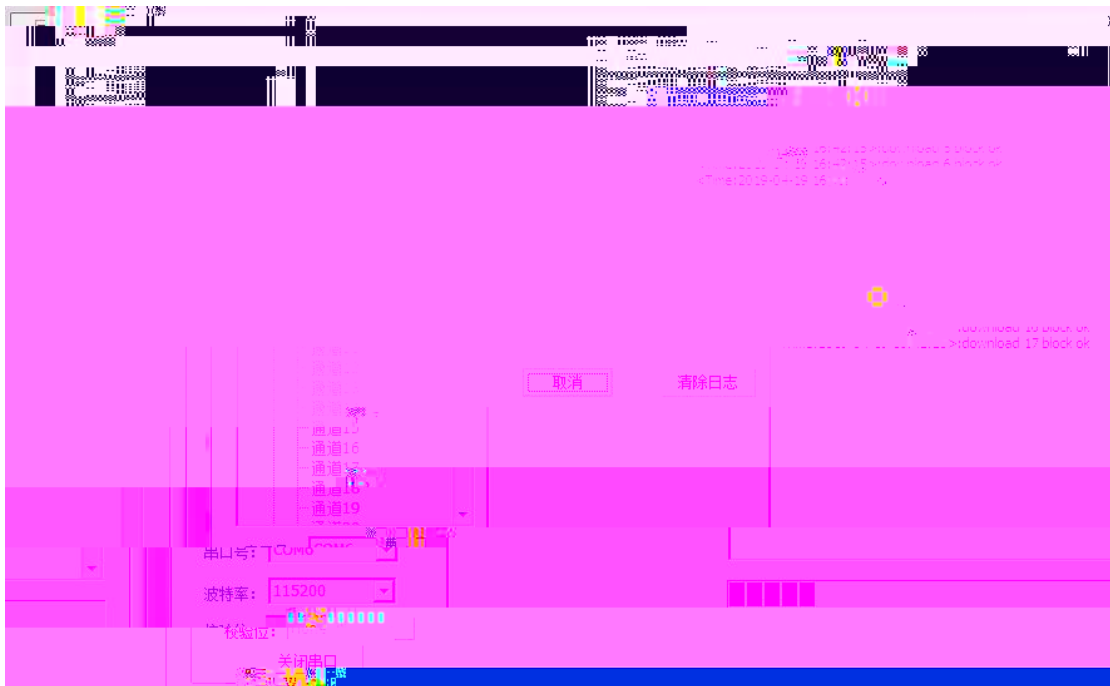

(" FH

Xckb` cUX gi WWgg c_

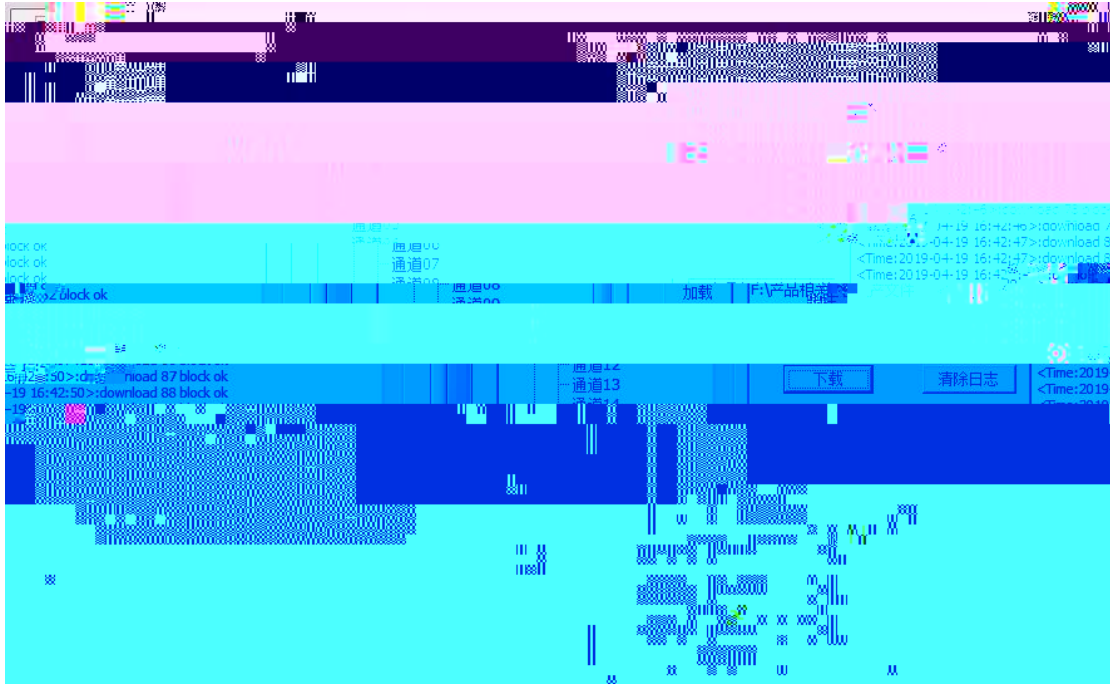

FH

5H

% FH7

| | 5H | |
|-----|-------------|------------------------------------|
| FH7 | 5HŽ9L77@1LL | 5HŽ9L77@1&\$% #\$(#% ž% .) % \$ž) |

&

| | 5H | |
|--|----------------|---|
| | 5HŽ7<BGJ@9Bmml | ?6 mm \$% ' \$ \$% ' \$ l %\$&(\$?6 5HŽ7<BGJ@9B\$%l(, \$ |
| | | mm \$% ' \$ \$% ' \$ l. \$ %\$% \$%, 8=\$! 8=+ &\$% &\$, 587\$! 587+ |

| | | |
|--|-----------------|--|
| | 5H7<BB@HMD9mm1l | ' \$% ' \$& F5=B\$! F5=B% ' \$' !' \$(D=\$! D=% (\$% (% \$% % *\$% ; F5M 5H7<BB@HMD9\$%\$%\$% |
|--|-----------------|--|

&" %

| | 5H | |
|--|------------------|--|
| | 5H7CA=: CD9Bmm1l | mm \$% % \$% % l \$ % 5H7CA=: CD9B\$%\$% |
| | 5H7CA7C@H-A9mm1l | mm \$% % \$% % l \$! *)' ') \$ 5H7CA7C@H-A9\$%\$%\$% |
| | 5H7CAGJH-A9mm1l | mm \$% % \$% % l \$! *)' ') \$ 5H7CAGJH-A9\$%\$%) |
| | 5H7CADKF8@Mmm1l | FH mm \$% % \$% % l \$! &) \$ 5H7CADKF8@M\$%\$%\$% |
| | 5H7CA577l mm1l l | mm \$% % \$% % l l 5H7CA577l \$%\$%\$%\$% |
| | 5H7CA=: l Dmm1l | mm \$% % \$% % l \$ % 5H7CA=: l D\$%\$%\$% |
| | 5H7CAI DH-A9mm1l | mm \$% % \$% % l \$! *)' ') \$ |

| | | | | |
|-------------------|--------------------------|------------|--------|---|
| | 5HŽ7CAI DH=A9\$%a) | | | |
| | | mm | \$% %) | % |
| 5HŽ7CA9@9Am1 | | | \$% %) | % |
| | 5HŽ7CA9@9A\$%a) | | | |
| | | mm | \$% %) | % |
| 5HŽ7CA65G9J 5@mm1 | | | \$% %) | % |
| | 5HŽ7CA65G9J 5@\$%a)! % & | | | |
| | | mm | \$% %) | % |
| 5HŽ7CA7CFFJ 5@mm1 | | | \$% %) | % |
| | 5HŽ7CA7CFFJ 5@\$%a)! % & | | | |
| | | mm | \$% %) | % |
| 5HŽ7CAI B=Hm1 | | | \$% %) | % |
| | 5HŽ7CAI B=H\$%a)! #g | | | |
| | | mm | \$% %) | % |
| | | l . \$ | | |
| | | % FG& & \$ | | |
| 5HŽ7CAHMD9mm1 | & FG& & % | | | |
| | ' FG(,)! \$ | | | |
| | (FG(,)! % | | | |
| | 5HŽ7CAHMD9\$%a)' | | | |
| | | mm | \$% %) | % |
| 5HŽ7CAGD998mm1 | | | \$% %) | % |
| | 5HŽ7CAGD998\$%a) - *\$\$ | | | |
| | | mm | \$% %) | % |
| 5HŽ7CAD5F=HMm1 | | | \$% %) | % |
| | 5HŽ7CAD5F=HM\$%a), B% | | | |
| | AcXVi g | | | |
| 5HŽ7CAA6588Fmm1 | | mm | \$% %) | % |

| | | |
|--|------------------|---|
| | 5H7CA@FA75A8@mml | mm \$% % \$% % l. \$! &)) \$ 5H7CA@FA75A8@m\$%l% |
| | 5H7CAF@HBMD9mml | mm \$% % \$% % l. \$ %%% %%%& 8C\$! 8C% &\$% &\$, ? \$! ?+ 5H7CAF@HBMD9\$m%l%\$% |
| | 5H7CAF@BJ5@mml | mm \$% % \$% % l. \$! & \$ 8C % 8C & 5H7CAF@BJ5@m\$%l% |

& 587

| 5H | | |
|----|-----------------|---|
| | 5H587=: CD9Bmml | 587 mm \$% \$, 587\$ 587+ l \$ % 5H587=: CD9B\$m%l% |
| | 5H5877C@H=A9mml | 587 mm \$% \$, 587\$ 587+ l \$! *)'') \$ 5H5877C@H=A9\$m%l%\$ |
| | 5H587GJH=A9mml | 587 mm \$% \$, 587\$ 587+ l \$! *)'') \$ 5H587GJH=A9\$m%l) |
| | 5H587DKF8@mml | FH mm \$% \$, 587\$ 587+ l \$! &)) \$ 5H587DKF8@m\$%l&\$ |
| | | |

5HŽ587@DDUB@%\$!%&\$

fl t

nm \$% \$, 587\$ 587+

5HŽ587@CKJ5@m1ll

ll

5HŽ587@CKJ5@\$%!%\$

nm \$% \$, 587\$ 587+

5HŽ587l DDFB; nm1ll

ll. (! &\$a5 \$!)

5HŽ587l DDFB; \$%l &\$

nm \$% \$, 587\$ 587+

5HŽ587@CKFB; nm1ll

ll. (! &\$a5 \$!)

5HŽ587@CKFB; \$%l (

5HŽ587@FAI DDnm1ll

| | | |
|--|------------------|---|
| | 5H587@FA75A8@mml | l. \$! &) \$ 5H587@FA75A8@m\$%l% |
| | 5H587F@HBMD9mml | mm \$% \$, 587\$ 587+ l. \$ %\$% %\$& 8C\$! 8C% &\$% &\$, ? \$! ?+ 5H587F@HBMD9\$m%l%\$% |
| | 5H587F@HBJ5@mml | mm \$% \$, 587\$ 587+ l. \$! & \$ 8C % 8C & 5H587F@HBJ5@m\$%l% |

&" ' 8=

| | 5H | |
|--|-----------------|---|
| | 5H5=C=: CD9Bmml | 8= mm \$% \$, 8=\$ 8=+ l \$ % 5H5=C=: CD9B\$m%l% |
| | 5H5=C@FACDmml | 8= mm \$% \$, 8=\$ 8=+ l \$ % & 5H5=C@FACD\$m%l% |
| | 5H5=CF@HBMD9mml | mm \$% \$, 8=\$ 8=+ l. \$ %\$% %\$& 8C\$! 8C% &\$% &\$, ? \$! ?+ 5H5=CF@HBMD9\$m%l%\$% |
| | 5H5=CF@HBJ5@mml | mm \$% \$, 8=\$ 8=+ l. \$! & \$ 8C % 8C |

| | | |
|----|---------------------|---|
| | | & 5H̃==CF@HBJ5@%1% |
| | 5H̃==C@FA75AG97mm1l | mm \$% \$, 8=\$ 8=+ l. \$! *)')') \$ 5H̃==C@FA75AG97\$%1\$ |
| =8 | 5H̃==C@FA75A=8mm1l | =8 mm \$% \$, 8=\$ 8=+ l. \$! &) 5H̃7CA@FA75A=8\$%1% |
| | 5H̃==C@FA75A8@mm1l | mm \$% \$, 8=\$ 8=+ l. \$! &) \$ 5H̃==C@FA75A8@%1% |

&" (

| | 5H | |
|--|--------------------|--|
| | 5H̃7BHF=: CD9Bmm1l | mm \$% \$(\$% \$& F5=B\$! F5=B%z\$' ! \$(D=\$! D=% l \$ % 5H̃7BHF=: CD9B\$%1% |
| | 5H̃7BHFCDmm1l | mm \$% \$(\$% \$& F5=B\$! F5=B%z\$' ! \$(D=\$! D=% l \$ % & ' 5H̃7BHFCD\$%1& |
| | 5H̃7BHF GJH=A9mm1l | mm \$% \$(\$% \$& F5=B\$! F5=B%z\$' ! \$(D=\$! D=% l \$! *)')') \$ 5H̃7BHF GJH=A9\$%1) |

| | | |
|--|---------------------|--|
| | 5HŽ7BHFDFK8@Mm1l | <p>FH</p> <p>mm % \$ (% \$ & F5=B\$! F5=B%ž\$' ! \$(</p> <p>D=\$! D=%</p> <p>l \$! &)) \$</p> <p>5HŽ7BHFDFK8@M\$%l &\$</p> |
| | 5HŽ7BHF B=Hm1l l | <p>*</p> <p>mm % \$ (% \$ & F5=B\$! F5=B%ž\$' ! \$(</p> <p>D=\$! D=%</p> <p>l l</p> <p>5HŽ7BHF B=H\$%l a' #g</p> |
| | 5HŽ7BHF G<5?9AGm1l | <p>mm % \$ (% \$ & F5=B\$! F5=B%ž\$' ! \$(</p> <p>D=\$! D=%</p> <p>l \$! *)') \$</p> <p>5HŽ7BHF G<5?9AG\$%l) \$</p> |
| | 5HŽ7BHF =: l Dm1l l | <p>mm % \$ (% \$ & F5=B\$! F5=B%ž\$' ! \$(</p> <p>D=\$! D=%</p> <p>l \$ %</p> <p>5HŽ7BHF =: l D\$%l %</p> |
| | 5HŽ7BHF l DH=A9m1l | <p>mm % \$ (% \$ & F5=B\$! F5=B%ž\$' ! \$(</p> <p>D=\$! D=%</p> <p>l \$! *)' ') \$</p> <p>5HŽ7BHF l DH=A9\$%l)</p> |
| | 5HŽ7BHF 577l mm1l l | <p>mm % \$ (% \$ & F5=B\$! F5=B%ž\$' ! \$(</p> <p>D=\$! D=%</p> <p>l l</p> <p>5HŽ7BHF 577l \$%l %' \$\$</p> |
| | 5HŽ7BHF 9@9Am1l l | <p>%</p> <p>mm % \$ (% \$ & F5=B\$! F5=B%ž\$' ! \$(</p> <p>D=\$! D=%</p> <p>l l</p> <p>5HŽ7BHF 9@9A\$%l</p> |
| | | |



mm \$% \$(\$% \$& F5=B\$! F5=B%z\$' ! \$(

5H7BHF65G9J5@m111

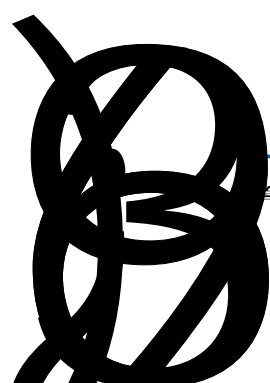
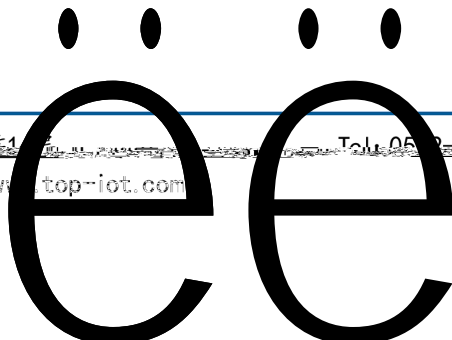

5HĹ; F5M65G9J5@1| |
5HĹ; F5M65G9J5@1! %' &

5HĹ; F5M7CFFJ5@1| |
5HĹ; F5M7CFFJ5@1% ' &

5HĹ; F5MB=H1| |
5HĹ; F5MB=H1a' #g

5HĹ; F5MFAI DD1| |
5HĹ; F5MFAI DD1%' &
ž è

5HĹ; F5MFA@CK1| |

| | | |
|--|------------------|---------------------------|
| | 5HŽ; F5Mf@BJ5@11 | & 5HŽ; F5Mf@BJ5@1% |
|--|------------------|---------------------------|

| | 5H | |
|--|---------------------|--|
| | 5HŽ896l ; 1l | l \$ % & 5HŽ896l ; 1& |
| | 5HŽ86; 7CAGD9981l | l FG& & \$ 5HŽ86; 7CAGD9981%& &\$\$ |
| | 5HŽ86; 7CAD5F=HMI l | ll , B% , 9% , C% 5HŽ86; 7CAD5F=HM, 9% |
| | 5HŽDFCHLH1l | l \$ <9L % 5G7== & 5HŽDFCHLH1& |
| | 5HŽM7588F1l l | ll %\$ 5HŽM7588F1\$\$\$\$\$%&& |
| | 5HŽ7BHF588F1l l | ll , %* 5HŽ7BHF588F1%\$&\$' : : % \$% & \$& ' \$' : : |
| | 5HŽ7CAI D5GG1l l | ll (ž% 5HŽ7CAI D5GG1%&' (|
| | 5HŽG=ABC1l l | ll % 5HŽG=ABC1% , %&' () *+, |
| | 5HŽDKF@CKJC@H1l l | ll 5HŽDKF@CKJC@H1%&) |
| | | l \$ |

| | |
|--------------------|-------------------------------------|
| 5HŽDFCHKF?1I | % & ' 5HŽDFCHKF?1& |
| 5HŽI D<CI FG1I | I \$ % 5HŽI D<CI FG1% |
| 5HŽI DBHFA=B1I | I \$! *)')') \$ 5HŽI DBHFA=B1) |
| 5HŽI DBHF<CI 1I | I \$! &(\$ 5HŽI DBHF<CI 1\$ |
| 5HŽI D@FAA=B1I | I \$! *)')') \$ 5HŽI D@FAA=B1\$ |
| 5HŽF5=B6; B<CI F1I | I \$! &(, , 5HŽF5=B6; B<CI F1, |
| 5HŽI DGH9DA=B1I | I \$! *)')') 5HŽI DGH9DA=B1) |
| 5HŽ=: I D6M@CG91I | I \$ % 5HŽ=: I D6M@CG91\$ |

| | | |
|--|-----------------|--|
| | 5HŽHF5BAC89mm1 | & . (DGHB) * + 8D 5HŽHF5BAC89\$% % |
| | 5HŽAI @H=G9Fmm1 | H7D# 8D =D mm \$% \$(% (\$)! \$, % (5HŽAI @H=G9F\$%] gcXYj " d Wd" bYh |
| | 5HŽAI @H=DCFHm1 | mm \$% \$(% (\$)! \$, % (\$! *)') 5HŽAI @H=DCFH\$% %\$%&% |
| | 5HŽAI @H=8BG\$% | 5HŽAI @H=8BG\$% , " , " , |
| | 5HŽAI @H=8BG\$& | 5HŽAI @H=8BG\$& , " , " , |

)

| | 5H | |
|-----|-------------------|------------------------------------|
| 5DB | 5HŽ5DB1 | 5DB 5DB ' - 5HŽ5DB1WábYh |
| 5DB | 5HŽI G9FB5A91 | ' - 5HŽI G9FB5A91 |
| 5DB | 5HŽI G9FD5GGKCF81 | ' - 5HŽI G9FD5GGKCF81 |
| 5DB | 5HŽ75@BC1 | &- |

5HŽ75@BC1

ž

5HŽ<FHG971I

I \$! *)')') \$

5HŽ<FHG971(\$

5HŽF97CBG971I

| | | |
|------|--------------------|---|
| | 5HŽ75A7CAD5F=HMm1l | mm \$% \$(% () l . , B%ž, 9%ž, C% 5HŽ75A7CAD5F=HM\$%l, B% |
| fl t | 5HŽ75AI DA=Bmm1l | mm \$% \$(% () l \$! *)') \$ 5HŽ75AI DA=B\$%l \$ |

+

| 5H | | |
|----|--------------------|---|
| | 5HŽ75AHAFCD9Bmm1l | mm \$% %\$ l \$ % 5HŽ75AHAFCD9B\$%l % |
| | 5HŽ75AHAF<Cl Fmm1l | mm \$% %\$ l \$! & 5HŽ75AHAF<Cl F\$%l %\$ |
| | 5HŽ75AHAF A=Bmm1l | mm \$% %\$ l \$!) - 5HŽ75AHAF<Cl F\$%l &\$ %\$" &\$ |

,

| 5H | | |
|----|-------------------|--|
| | 5HŽGAG9H1l | FH l \$ % 5HŽGAG9H1% |
| | 5HŽGAG58A=BBC1l l | FH l 5HŽGAG58A=BBC1% , %& () *+ , % , %& () *+- |

-

| 5H | | |
|----|--|--|
|----|--|--|

(_____)

| | | |
|--|--------------------|--|
| | 5HŽHF5B7CAHMD91I | % FG& & \$ & FG& & % ' FG(,)! \$ (FG(,)! % 5HŽHF5B7CAHMD91& |
| | 5HŽHF5B7CAGD9981I | 5HŽHF5B7CAGD9981!%) &\$ \$ |
| | 5HŽHF5B7CAD5F=HM I | ! . , B%ž, 9%ž, C% 5HŽHF5B7CAD5F=HM\$%!, B% |

| | | | |
|----|-------------------------|-------|---|
| \$ | l bg] [bYX %*V] h 56 | % & | \$% \$' \$& %% && \$8 ' (% &&%% %\$, +&% |
| % | l bg] [bYX %*V] h 65 | % & | \$% \$' \$& %% && \$8 ' (% %&& %\$ (' , * |
| & | G] [bYX %*V] h 56 | % & | \$% \$' \$& %% && \$8 ' (% &&%% %\$, +&% |
| ' | G] [bYX %*V] h 65 | % & | \$% \$' \$& %% && \$8 ' (% %&& %\$ (' , * |
| (| l bg] [bYX ' &V] h 5678 | ' & (| \$% \$' \$& %% && ' ' ((7* 7' % ((' &&%% %\$ %%((&\$%+) |
|) | l bg] [bYX ' &V] h 6587 | ' & (| \$% \$' \$& %% && ' ' ((7* 7' % ' ' ((%&& %\$, *\$-\$, ,)\$ |
| * | l bg] [bYX ' &V] h 7856 | ' & (| \$% \$' \$& %% && ' ' ((7* 7' % &&%((' %\$)+%) *- %) |
| + | l bg] [bYX ' &V] h 8765 | ' & (| \$% \$' \$& %% && ' ' ((7* 7' % %&&' ((%\$ & +)(\$&\$ |
| , | G] [bYX ' &V] h 5678 | ' & (| \$% \$' \$& %% && ' ' ((7* 7' % ((' &&%% |

| - | G][bYX ' &V]h 6587 | ' & | (| %\$ | %%((&\$%+() |
|-----|--------------------|-----|---|---------|------------------------|
| | | | | \$% \$' | \$& %& && ' ' ((7* 7' |
| | | | | %* | ' ' ((%&& |
| | | | | %\$ | , *\$-\$, ,) \$ |
| %\$ | G][bYX ' &V]h 7856 | ' & | (| \$% \$' | \$& %& && ' ' ((7* 7' |
| | | | | %* | &&%%(' ' |
| | | | | %\$ |) +%&)* - %& |
| %% | G][bYX ' &V]h 8765 | ' & | (| \$% \$' | \$& %& && ' ' ((7* 7' |
| | | | | %* | %&&' ((|
| | | | | %\$ | & +()) (\$&\$ |
| %& | : `cUh 5678 | ' & | (| \$% \$' | \$& %& && ' ' ((7* 7' |
| | | | | %* | ((' &&%% |
| | | | | | +%" ' && , |
| % | : `cUh 6587 | ' & | (| \$% \$' | \$& %& && ' ' ((7* 7' |
| | | | | %* | ' ' ((%&& |
| | | | | | \$" \$\$\$\$\$\$ |
| % | : `cUh 7856 | ' & | (| \$% \$' | \$& %& && ' ' ((7* 7' |
| | | | | %* | &&%%(' ' |
| | | | | | \$" \$\$\$\$\$\$ |
| % | : `cUh 8765 | ' & | (| \$% \$' | \$& %& && ' ' ((7* 7' |
| | | | | %* | %&&' ((|
| | | | | | \$" \$\$\$\$\$\$ |



kkk" hcd!] ch" V@a
gYfj] WY4hcd!] ch" V@a