

&\$%! \$, ! &*	J% \$		
&\$&\$! \$*! %	J&" \$	587 8=	
&\$&\$! \$+! \$,	J' " \$		



%"	4
%&	4
%'	5
&"%	7
&"&	7
&"'	8
&"(9
&")	11
&"*	11
&" +	11
&" ,	11
FH	
' "%	12
' "% & FH	12
' "'	12
' "(12
' ")	12
FH	
("%	13
("&	13
("' FH	13
("(13
(")	13
)"%	14
)"&	14
)"'	19
*"%	20

%'

%' "%

7DI ' &
: @5G<)%&?6
GF5A &)^?6

%' "% &

%' "'

	87 %&J#%)5
	87)r' *J
	(\$a5 ()a54%&J87
	(\$a5 *\$a54%&J87

% ' " (

	=D \$
	%\$y %\$y & aa fl y y Ț
	' &\$[

% ' ")

	!)rZ+) 7
	!(\$rZ,) 7
	-)i fl Ț

&" %

&" &

&" &" %

◇ % fl 匕

◇ fIGA5 匕 %

◇ %&J87#%) 5 %

◇ FG&' & %

◇ %& D=B % %\$ D=B %

◇

◇

&"'

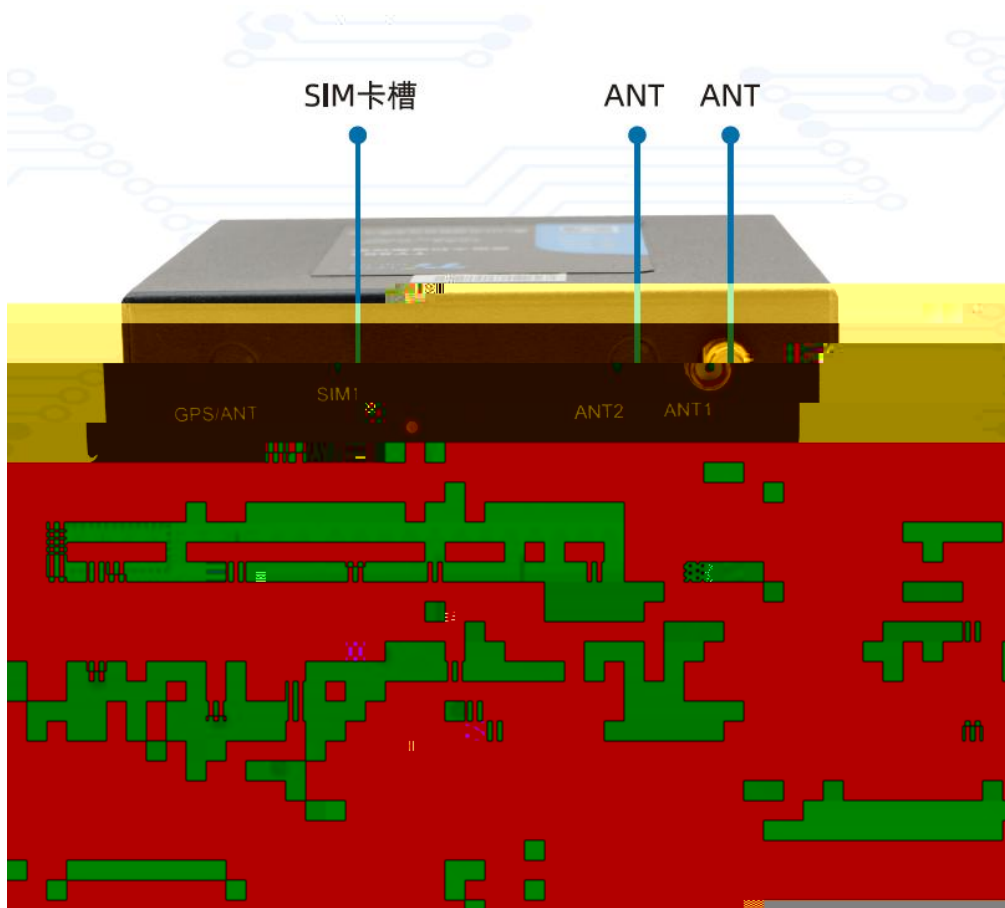

%	J=BŽ		
&	J=B!		
'	; B8	& &	
(FL8\$	& &	
)	HL8\$	& &	
*	5\$	(,) 5	
+	6\$	(,) 6	
,	8=\$	\$	5%

-	8=%	%	6%
;%\$;B8	&' &	
%%	FL8%	&' &	8=&#H@#D=\$
%&	HL8%	&' &	8=' #H@#D=%
%	J88SCI H	%&J	
%{	;B8		
%)	587\$	\$	
%*	587%	%	8C\$
%+	587&	&	8C%
%	B7		587'
%	?\$Z		
&\$?\$!		
&%	?%Z		
&&	?%&		

&" (

FH

& ! %* 5K;

&" (" %

%&J87#%") 5

FG&' &

86-

	86-
	&
	,
)

&" (" &

)!' *J87

(K



FG& &

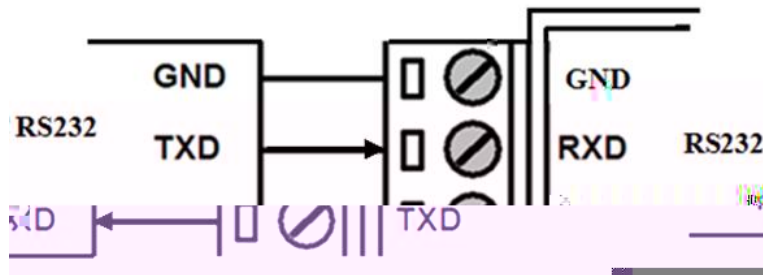

FG(,)

FG(,)

- *\$\$ Vdg

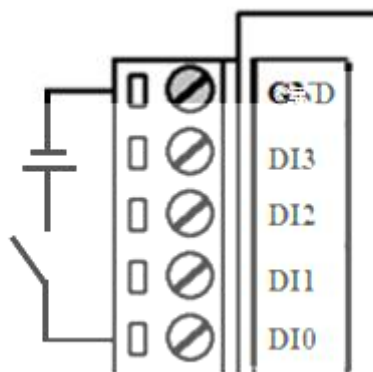
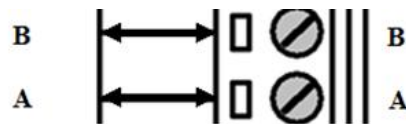

' \$J87

%

' \$K

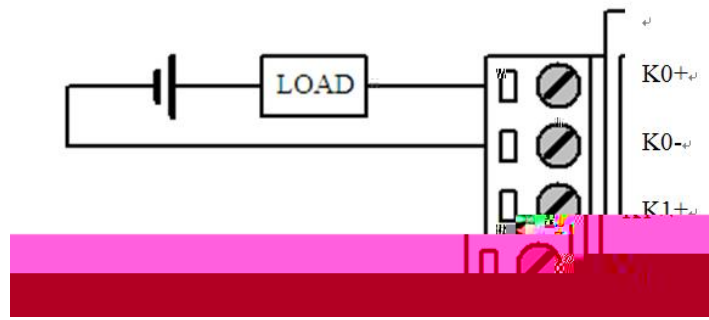

(! &\$a5

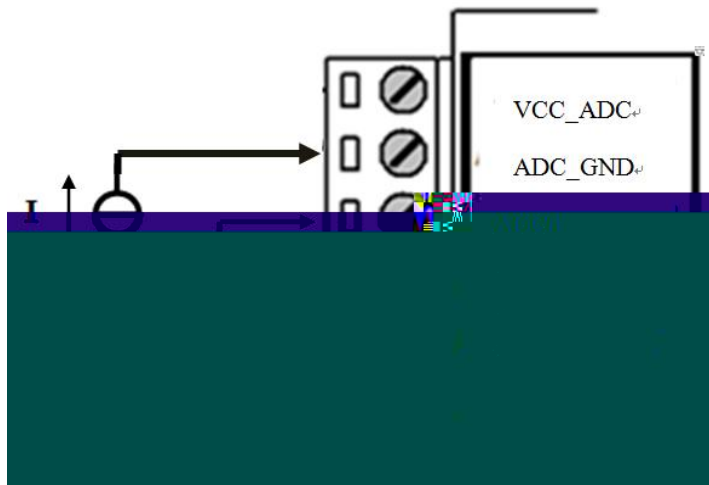

(! &\$a5

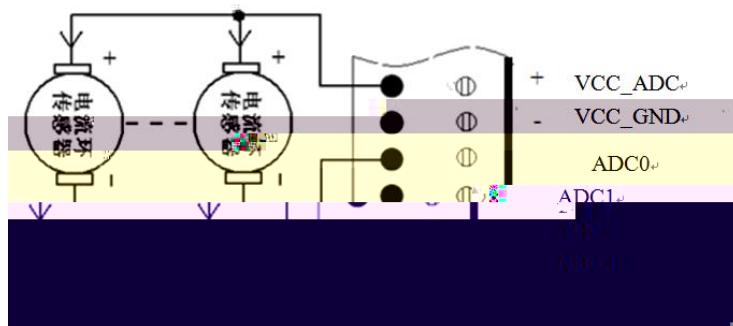

&")

%&J87#%) 5

)r' *J

' \$\$aJ

' *J

(K

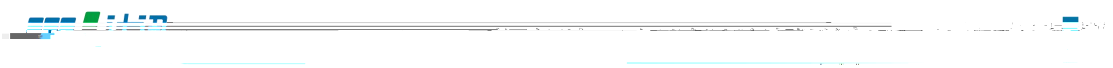

%J87#%) 5

&" *

DKF		
GMB		
Ob]bY		
9ffcF		

&" +

*

A(

&" ,

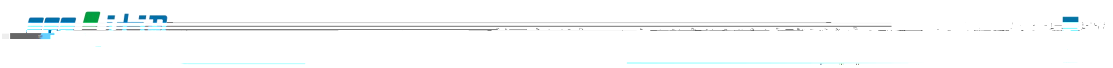

FH

' "%

)

AC86I G FH

' "&

' "'

AC86I G FH

' "(

\YI

' ")

FH

FGI & &

FH

FG& & % D7

D7

FH



FH

(" %

(" % %

FG& &

FH

FH

(" &

7CA% %&) &\$\$

""

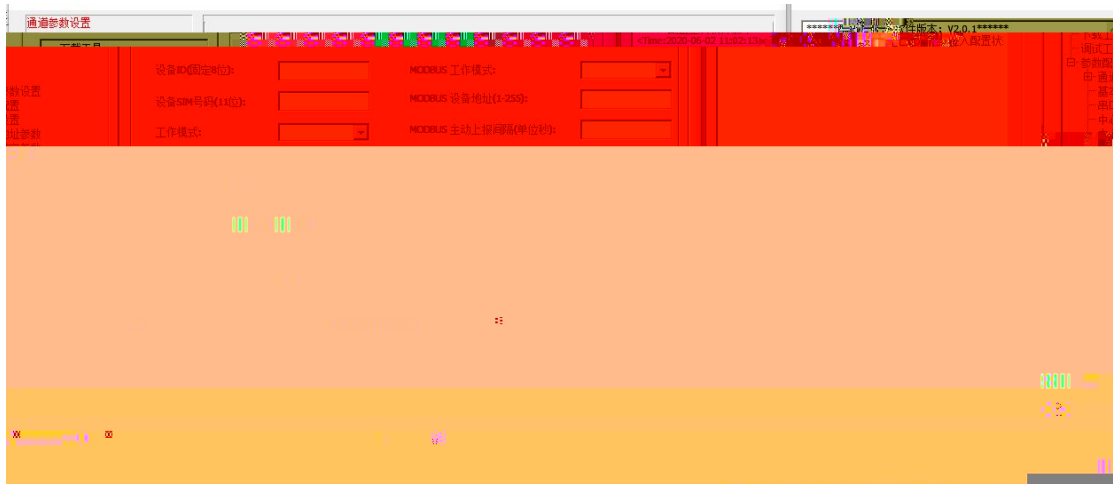

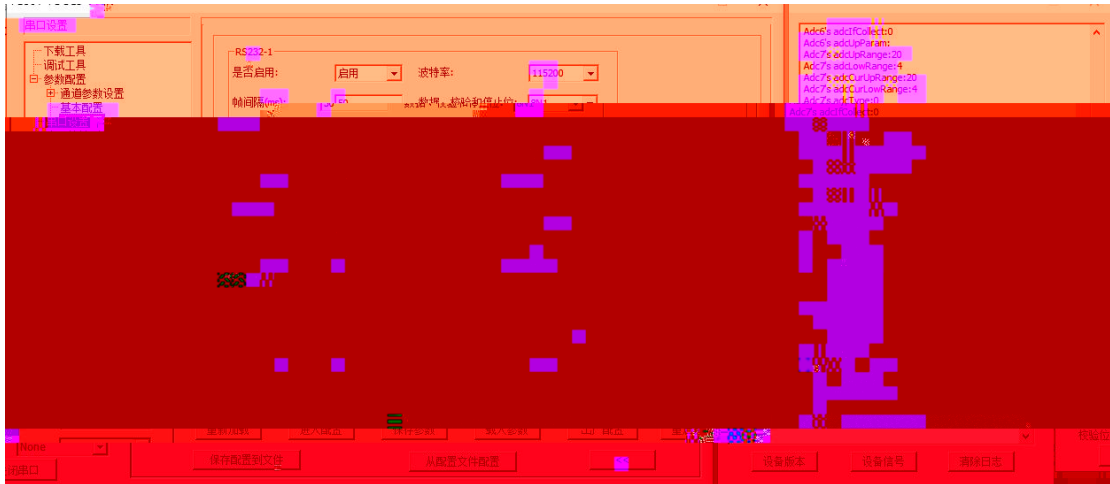

	FG&' & %FG(,)! \$ FG(,)! % (,)! %	H) \$ %FG(,)
	, 9%ž, B% ž, C%ž	
	%\$	
<YI		\YI

(" &"

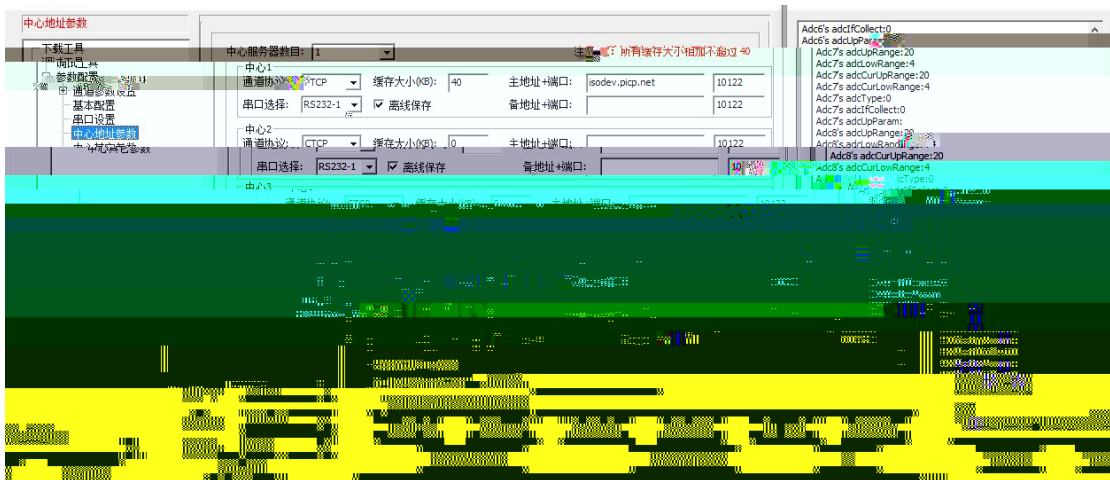

	H7D#1 8D	=D
	GAG	
	H7D#1 8D	
	H7D#1 8D	
8BG		=D
	H7D#1 8D	
8BG		=D

(" &" (

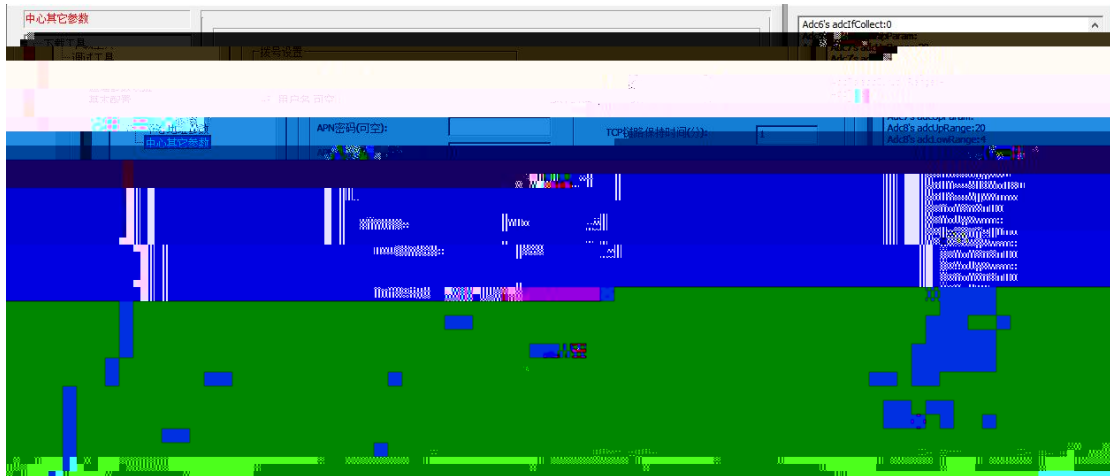

5DB		
5DB		
5DB		
5DB		
	H7D *\$ I 8D ' %	
	U hc	
: H7D	: H7D	

	\\VI
	\\VI

(" &" 587

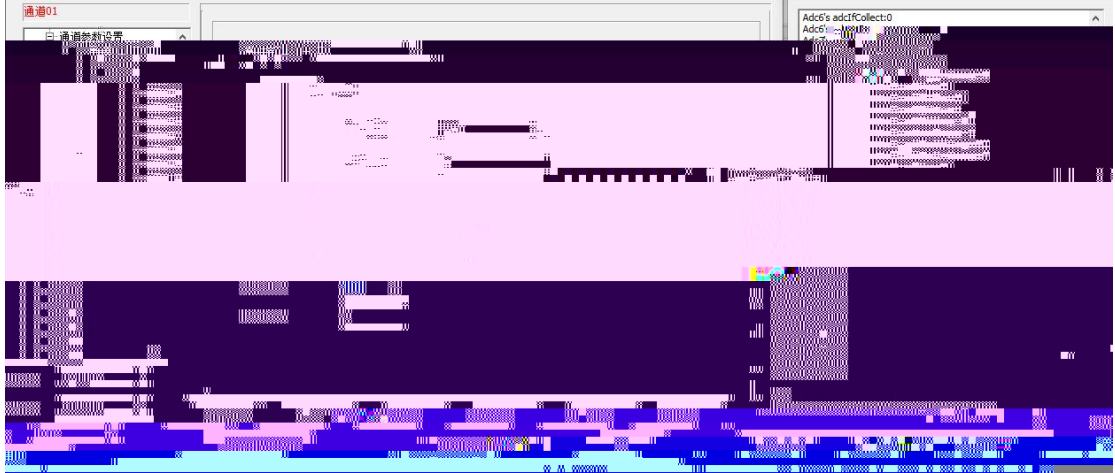

587	#
	UXW UXW\$z

(" &" * 8=

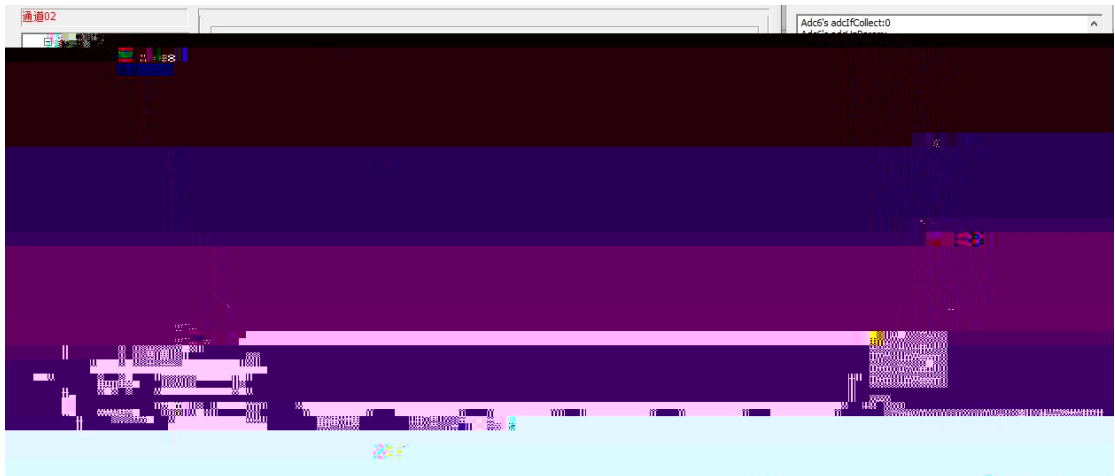

--	--

	X]
	X]z

)"%

FG&' &

FG&' & (,)

FH

D7

FH

%

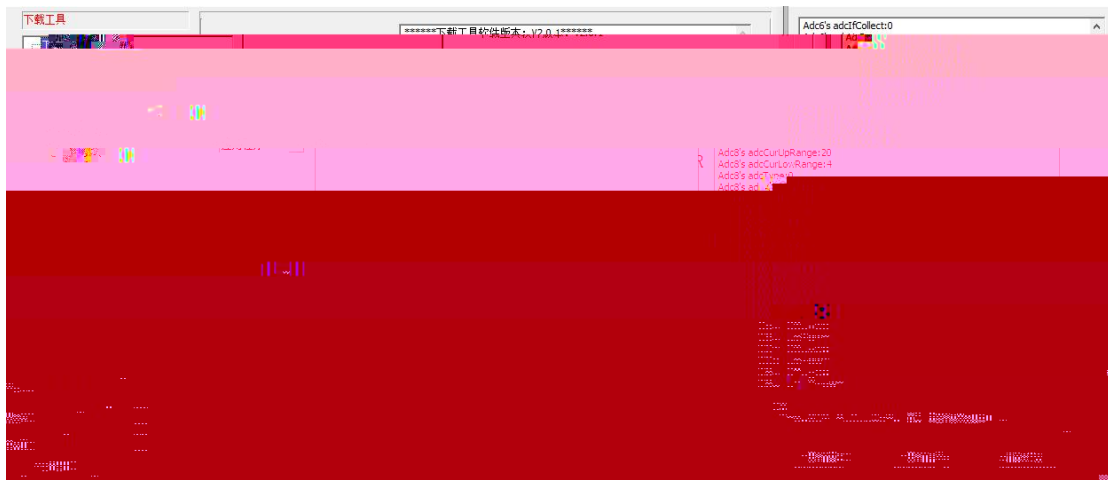

&"

6=B



' " FH



(" FH

o%

g a	5HŽG=ABC1	% 5HŽG=ABC1% , %&' () * +,
acXVI g % &))	5HŽA6588F1	 5HŽA6588F1&
	5HŽDFCHLH1	\$ Xhi % AC89A 5HŽDFCHLH1\$
AcXVI g	5HŽA6I DG971	 5HŽA6I DG971%\$
FH7	5HŽ9L77@1LL	5HŽ9L77@1&\$% #\$(# % ž% .) % \$\$ž)

&

	5H	
--	----	--

mm

5HŽ7CA=: 9Bmm1| |

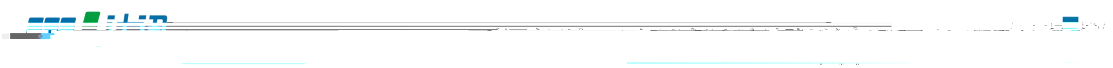

% FG& & \$
 & FG(,)! \$
 | . , B%ž, 9%ž, C%
 5HŽ7CAD5F=HM\$%đ, 9%

nm .
 % %\$ % %\$
 L.

5HŽ89H5=@7CBHm1l

5HŽ89H5=@7CBH\$' 1\Y` ` c

\Yl 5HŽ89H5=@7C89m1l

		& <H7D ' BI 8D (7I 8D) <I 8D 5HŽHF5BAC89\$%I%
	5HŽG9FGJ@9Bmm1I I	mm \$% \$) %)) 5HŽG9FGJ@9B\$I*\$
	5HŽAI @H-G9Fmm1I I	H7D#I 8D =D mm \$% \$) %) \$*! %\$ %) 5HŽAI @H-G9F\$I] gcXYj " d] Wd" bYh
	5HŽAI @H-DCFHm1I I	mm \$% \$) %) \$*! %\$ %) \$! *)') 5HŽAI @H-DCFH\$I%\$%&%
	5HŽG9F7CAHMD9mm1I I	mm \$% \$) %)) \$ Fg& & % % Fg(,)! \$ 5HŽG9F7CAHMD9\$I%
	5HŽG9FGJ.C : mm1I I	mm \$% \$) %)) \$ % 5HŽG9FGJ.C : \$%I \$

	5HŽAI @H-G9Fmm1	H7D#1 8D =D mm \$% \$) %) \$*! %\$ %) 5HŽAI @H-G9F\$*1]gcXYj " d]Vd" bYh
	5HŽAI @H-DCFHm1	mm \$% \$) %) \$*! %\$ %) \$! *)')' 5HŽAI @H-DCFH\$*1%\$%&%
	5HŽAI @H-8BG\$%	 5HŽAI @H-8BG\$% , ", ", "
	5HŽAI @H-8BG\$&	 5HŽAI @H-8BG\$&1, ", ", "

(

	5H	
5DB	5HŽI G9FB5A91	' - 5HŽI G9FB5A91
5DB	5HŽI G9FD5GGKCF81	' - 5HŽI G9FD5GGKCF81
5DB	5HŽ75@BC	&- 5HŽ75@BC1
	5HŽ<FHG971	ž \$! *)')') \$ 5HŽ<FHG971(\$
	5HŽF97CBG971	\$! *)')') \$ 5HŽF97CBG971%\$

HVD	5HŽ?D@A=B1I	I 5HŽ?D@A=B1%&
	5HŽB9HAC891I	L. \$ U hc % ; GA cb` m & H8! G78A5 cb` m ' . K78A5 cb` m (" 78A5 cb` m)" <8F cb` m *" @H9 cb` m 5HŽB9HAC891\$
: H7D	5HŽ7CBI 9FH1I	: H7D I . \$ z% z 5HŽ7CBI 9FH1\$
	5HŽG9@ @ B1I	© 8 518 I . 5HŽG9@ @ B1\Y` `c
	5HŽG9@ <FH1I	I . 518H 5HŽG9@ <FH1\Y` `c
	5HŽG9@ @ B<9L1I	I . \$ z% % J ! 5HŽG9@ @ B<9L1\$
	5HŽG9@ <FH<9L1I	I . \$ z% % 5HŽF97CBG971%\$ 5HŽG9@ @ B<9L1\$

) 587

984B

518

B

	5H587@CKFB; mm111	fl t mm \$% \$' 587\$ 587& 11 5H587@CKF5B; 9\$%1 (
	5H58771 FI D@mm111	mm \$% \$' 587\$ 587& 11. (! &\$a5 \$!) 5H58771 FI D\$%1 &\$
	5H58771 F@CKmm111	mm \$% \$' 587\$ 587& 11. (! &\$a5 \$!) 5H58771 F@CK\$%1 (
	5H587=: 7C@@97Hm111	mm \$% \$' 587\$ 587+& 11. \$ % 5H587=: 7C@@97H\$%1 %
	5H5871 DD5F5Amm111	mm \$% \$' 587\$ 587& 11. 5H5871 DD5F5A\$%1 * \$

* 8=

	5H	
	5H8=: 7C@@97Hm111	mm \$% \$& 8=\$ 8=% 11. \$ % 5H8=: 7C@@97H\$%1 %
	5H8=I DD5F5Amm111	mm \$% \$& 8=\$ 8=% 11. 5H8=I DD5F5A\$%1 * \$



%	:`cUh 6587	' & (\$% '\$ \$& %% && ' ' ((7* 7' %* ' ' ((%&& \$" \$\$\$\$\$\$
%	:`cUh 7856	' & (\$% '\$ \$& %% && ' ' ((7* 7' %* &&%%(' ' \$" \$\$\$\$\$\$
%	:`cUh 8765	' & (\$% '\$ \$& %% && ' ' ((7* 7' %* %&&' ' ((\$" \$\$\$\$\$\$



Tel: 0592-6211770

Web [kkk"hcd! \]ch"Vta](#)

Mail: [gYfj \]V4hcd! \]ch"Vta](#)

F14 27-28 C07 14

É . r